

B PLAN
SCALE 1 : 50

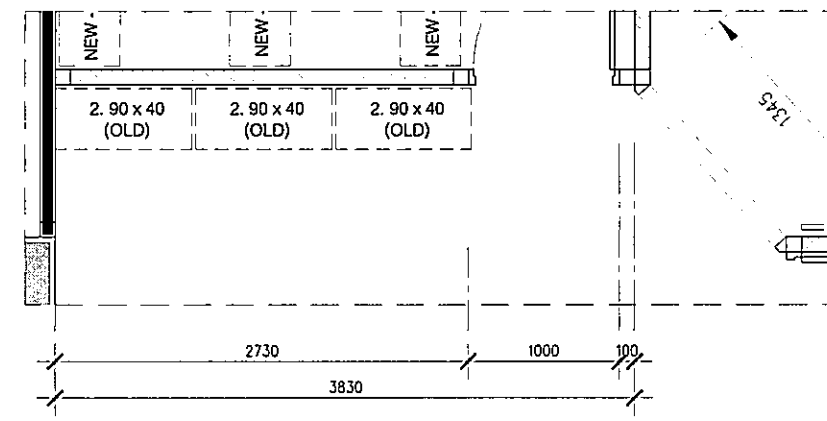

B PLAN
SCALE 1 : 50

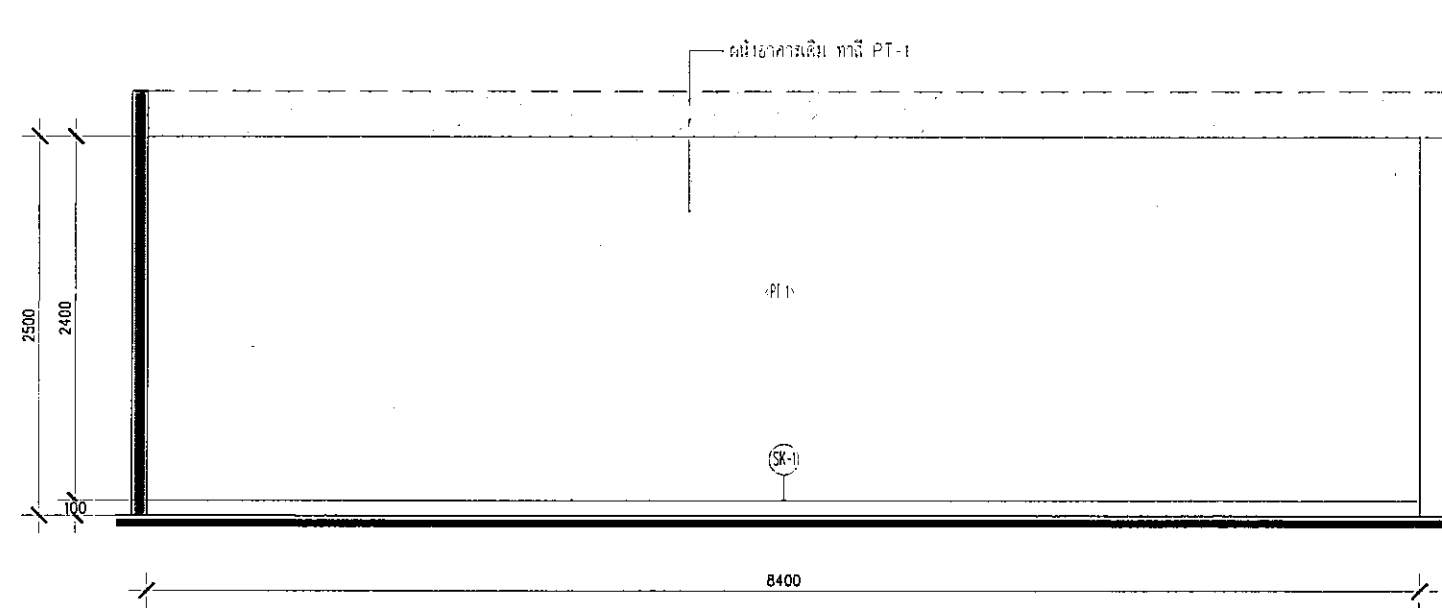

B ELEVATION
SCALE 1 : 50

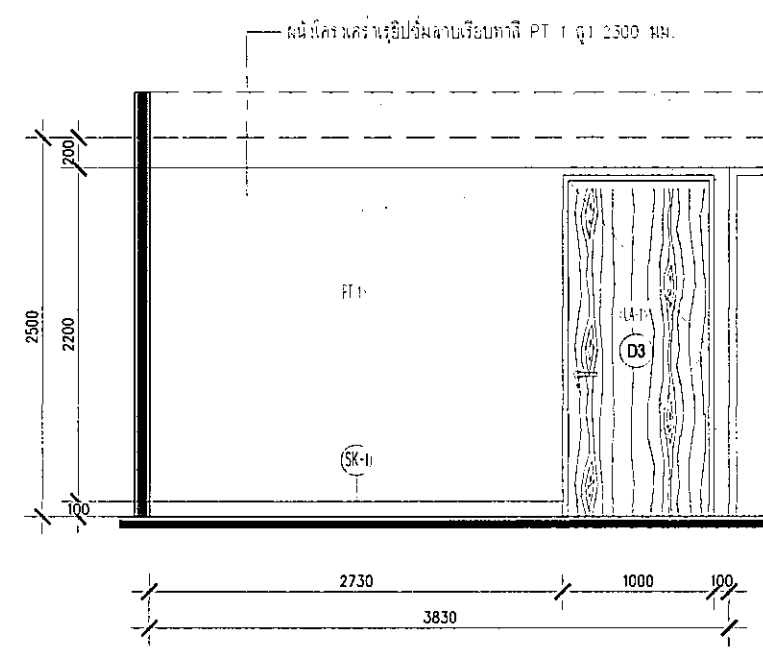

B ELEVATION
SCALE 1 : 50

FINISHES LEGEND

CODE	DESCRIPTION	SPECIFICATION
LA-1	LAMINATE ทรายไม้	LAMITAK CODE : WY 1281 D
LA-2	LAMINATE สีน้ำเงินคาน	LAMITAK CODE : SCX 1154 D

CODE	DESCRIPTION	SPECIFICATION
PT-1	ผนังทาสีเทา	TOA SUPER SHILE CODE : M100

CODE	DESCRIPTION	SPECIFICATION
MR-1	กระจกใสหนา 8 มม.	
MR-2	GLASS KOTE	สีชาวนหนา 8 มม.
MR-3	GLASS KOTE	สีน้ำเงินหนา 8 มม.

Handwritten signature and initials



Project.
GISTDA HEAD OFFICE
Government Complex - Building B

Drawing Title.
ELEVATION

Revision No.	3	Scale.	1 : 50
Date.	23/08/2018	Drawing No.	ID-10

Do not scale. All measurements are to be checked at site and discretion are to be reported. Drawing is copyright

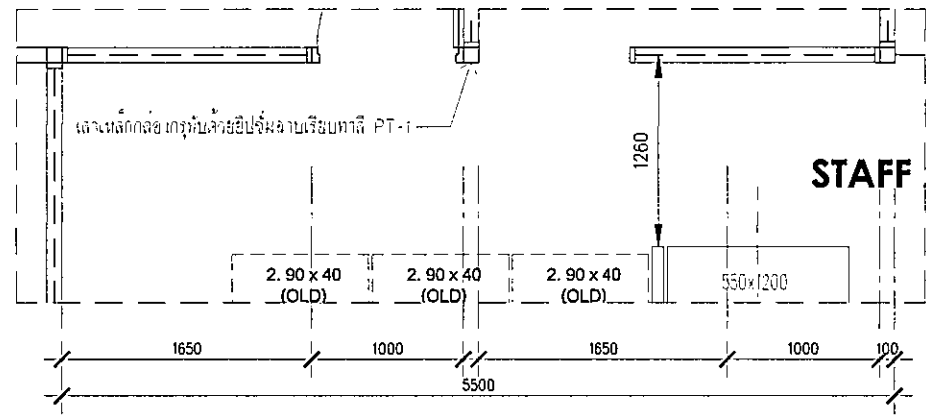

E PLAN
SCALE 1 : 50

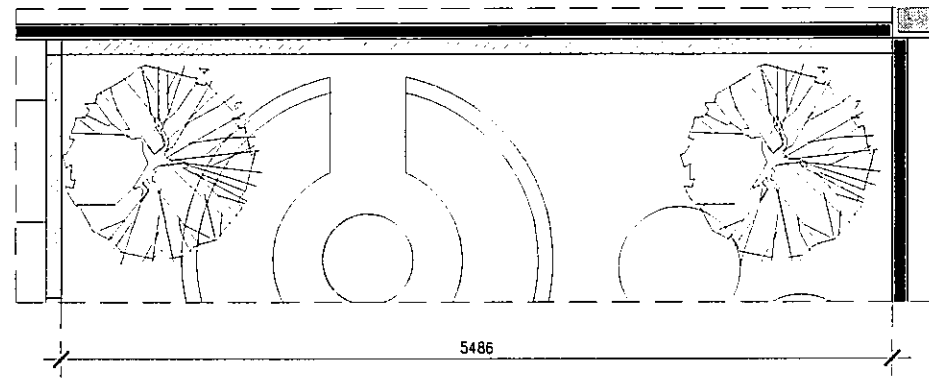

C PLAN
SCALE 1 : 50

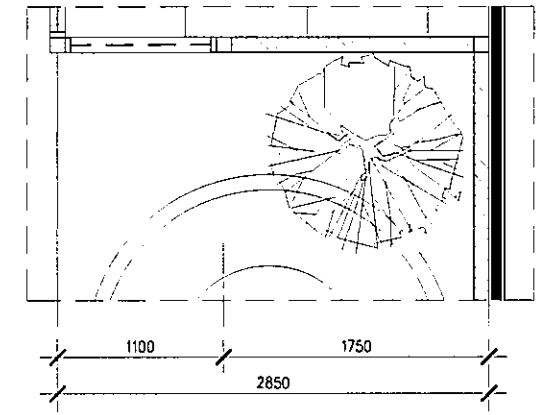

D PLAN
SCALE 1 : 50

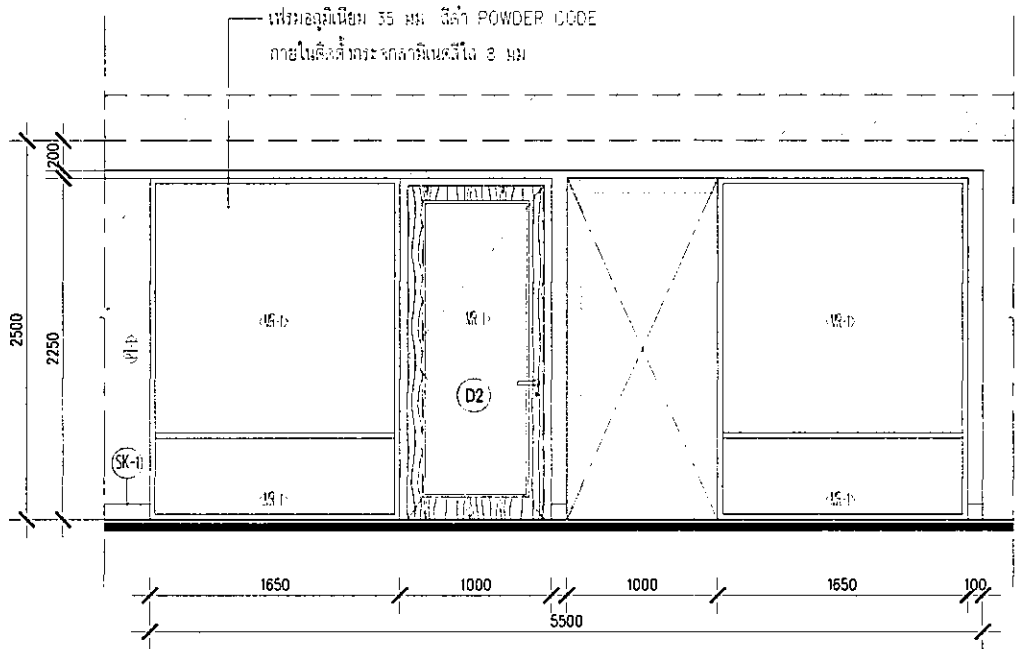

E ELEVATION
SCALE 1 : 50

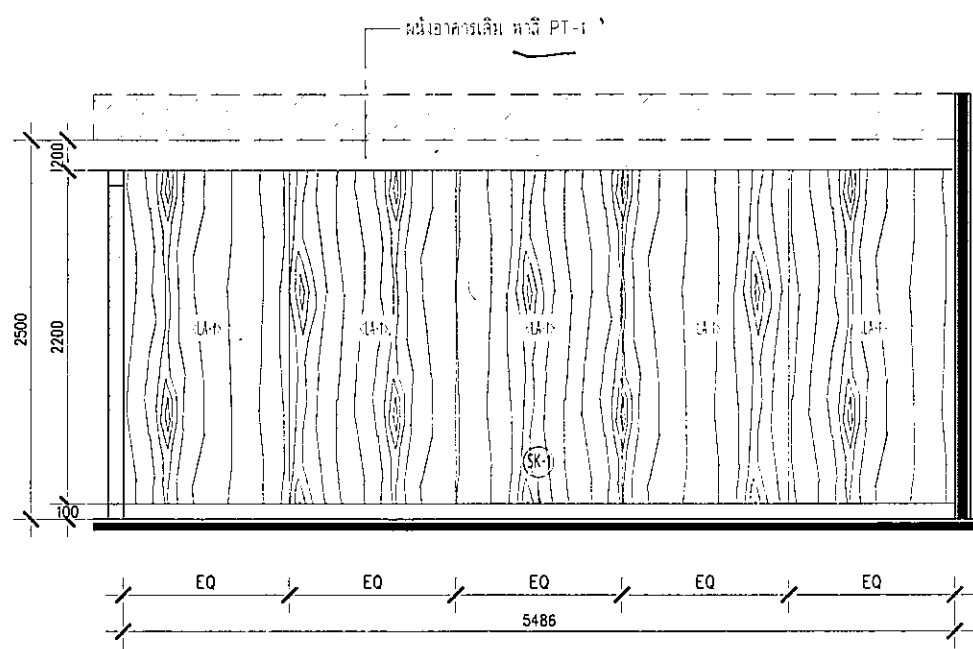

C ELEVATION
SCALE 1 : 50

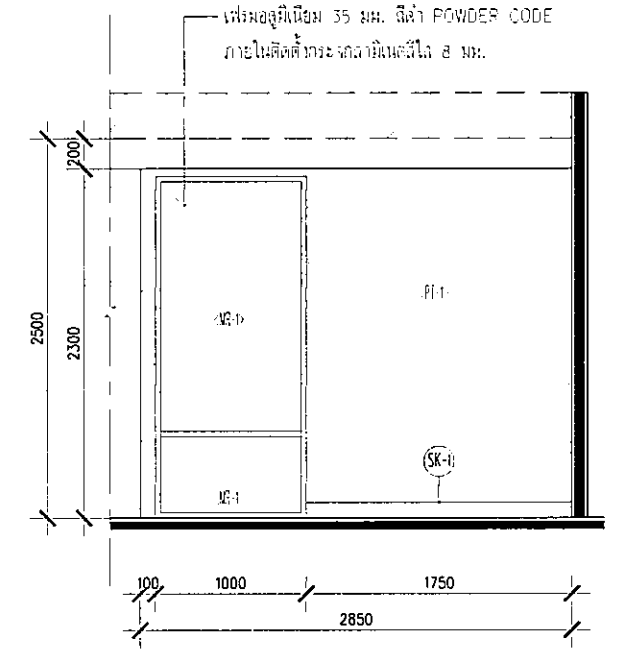

D ELEVATION
SCALE 1 : 50

FINISHES LEGEND

CODE	DESCRIPTION	SPECIFICATION
LA-1	LAMINATE ทรายหิน	LAMITAK CODE : WY 1281 D
LA-2	LAMINATE สีน้ำเงินดำ	LAMITAK CODE : SCX 1154 D

CODE	DESCRIPTION	SPECIFICATION
PT-1	ผนังทาสีขาว	TOA SUPER SHILE CODE : M100

CODE	DESCRIPTION	SPECIFICATION
MR-1	กระจกใสหนา 8 มม.	
MR-2	GLASS KOTE	สีชาวนา 8 มม.
MR-3	GLASS KOTE	สีน้ำเงินหนา 8 มม.

Handwritten signature and initials



Project. **GISTDA HEAD OFFICE**
Government Complex - Building B

Drawing Title. **ELEVATION**

Revision No.	3	Scale.	1 : 50
Date.	23/08/2018	Drawing No.	ID-11

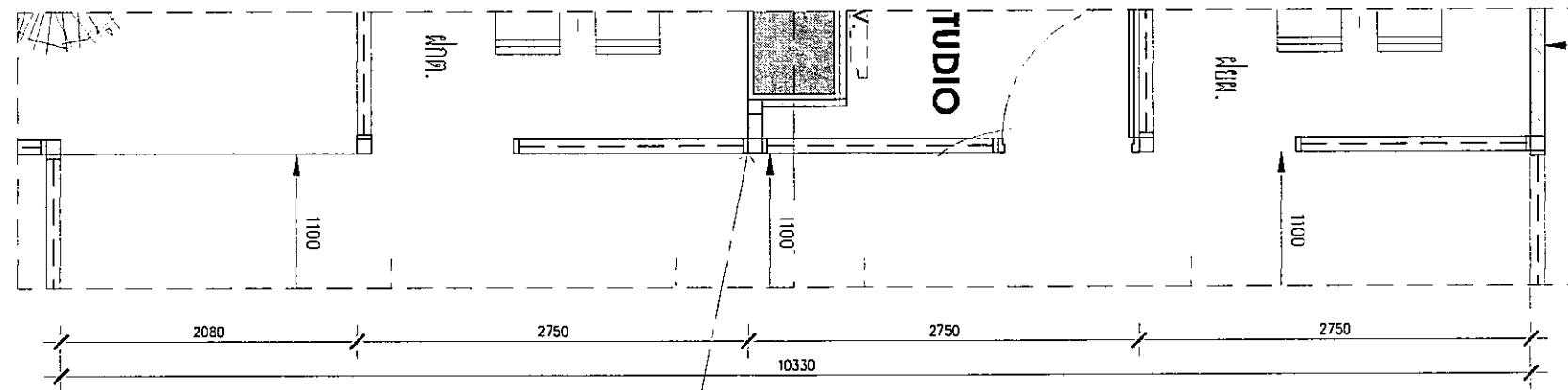

F PLAN
SCALE 1 : 50

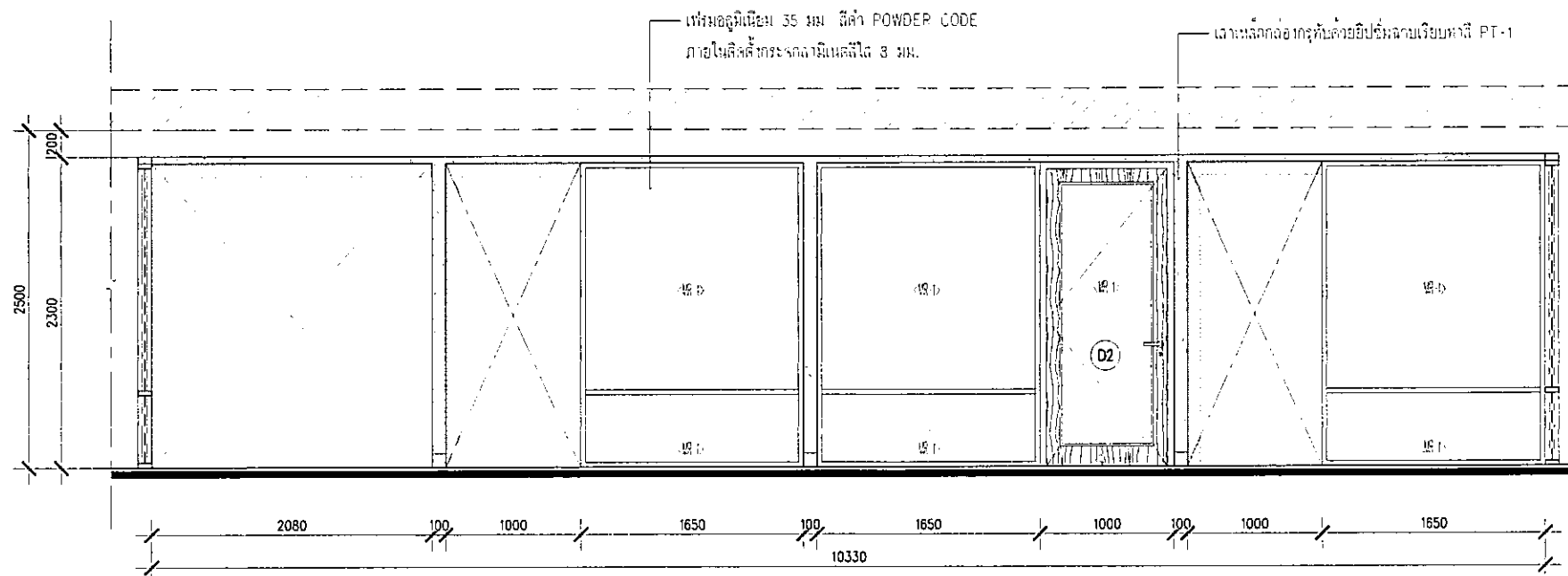

F ELEVATION
SCALE 1 : 50

FINISHES LEGEND

CODE	DESCRIPTION	SPECIFICATION
LA-1	LAMINATE ตายไม้	LAMITAK CODE : WY 1281 D
LA-2	LAMINATE สีน้ำเงินดำ	LAMITAK CODE : SCX 1154 D

CODE	DESCRIPTION	SPECIFICATION
PT-1	ผนังทาสีขาว	TOA SUPER SHILE CODE : M100

CODE	DESCRIPTION	SPECIFICATION
MR-1	กระจกใสหนา 8 มม.	
MR-2	GLASS KOTE	สีชาวนา 8 มม.
MR-3	GLASS KOTE	สีน้ำเงินหนา 8 มม.

Handwritten notes and signatures in the bottom right corner of the drawing area.



Project.

GISTDA HEAD OFFICE
Government Complex - Building B

Drawing Title.

ELEVATION

Revision No.

3

Scale.

1 : 50

Date.

23/08/2018

Drawing No.

ID-12

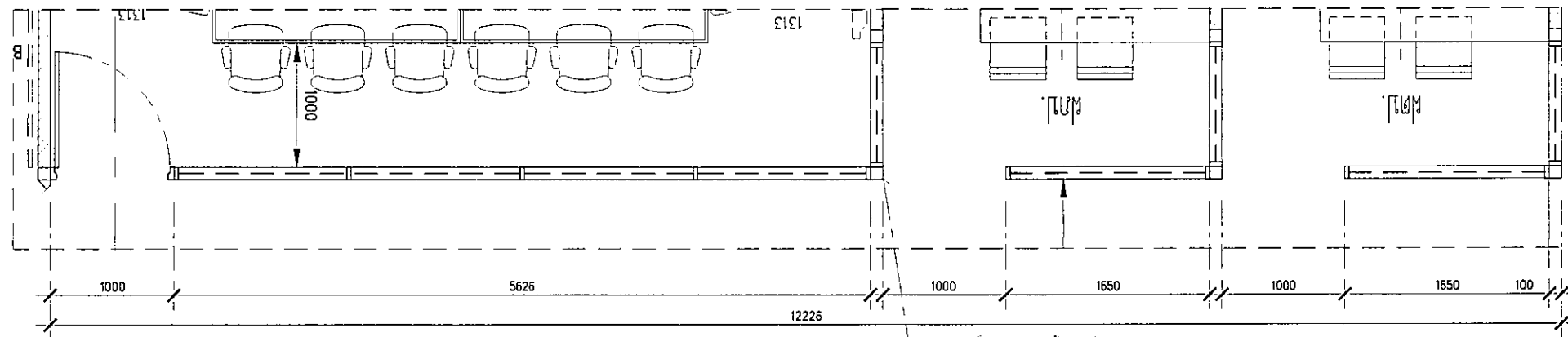

G PLAN
SCALE 1 : 50

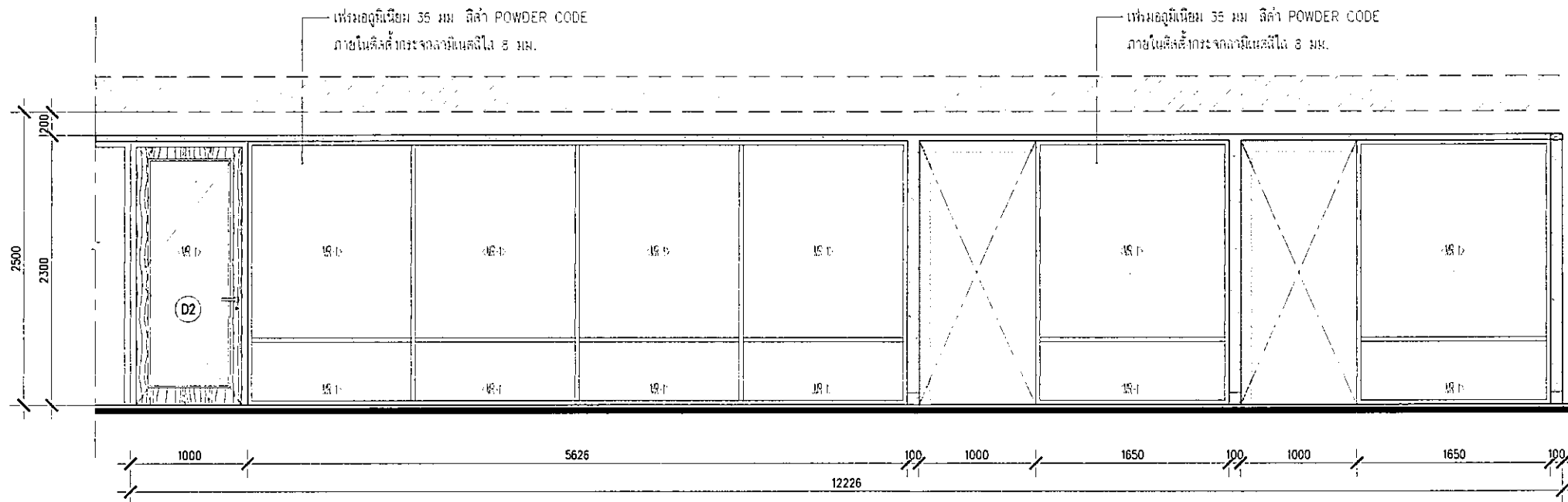

G ELEVATION
SCALE 1 : 50

FINISHES LEGEND

CODE	DESCRIPTION	SPECIFICATION
LA-1	LAMINATE ทรายโท	LAMITAK CODE : WY 1281 D
LA-2	LAMINATE สีเทาเงินดำ	LAMITAK CODE : SCX 1154 D

CODE	DESCRIPTION	SPECIFICATION
PT-1	ผนังทาสีขาว	TOA SUPER SHILE CODE : M100

CODE	DESCRIPTION	SPECIFICATION
MR-1	กระจกใสหนา 8 มม.	
MR-2	GLASS KOTE	สีชาวนหนา 8 มม.
MR-3	GLASS KOTE	สีน้ำเงินหนา 8 มม.

Handwritten signature and initials.



Project.
GISTDA HEAD OFFICE
Government Complex - Building B

Drawing Title.
ELEVATION

Revision No.	3	Scale.	1 : 50
Date.	23/08/2018	Drawing No.	ID-13

Do not scale. All measurements are to be checked at site and discretion are to be reported. Drawing is copyright

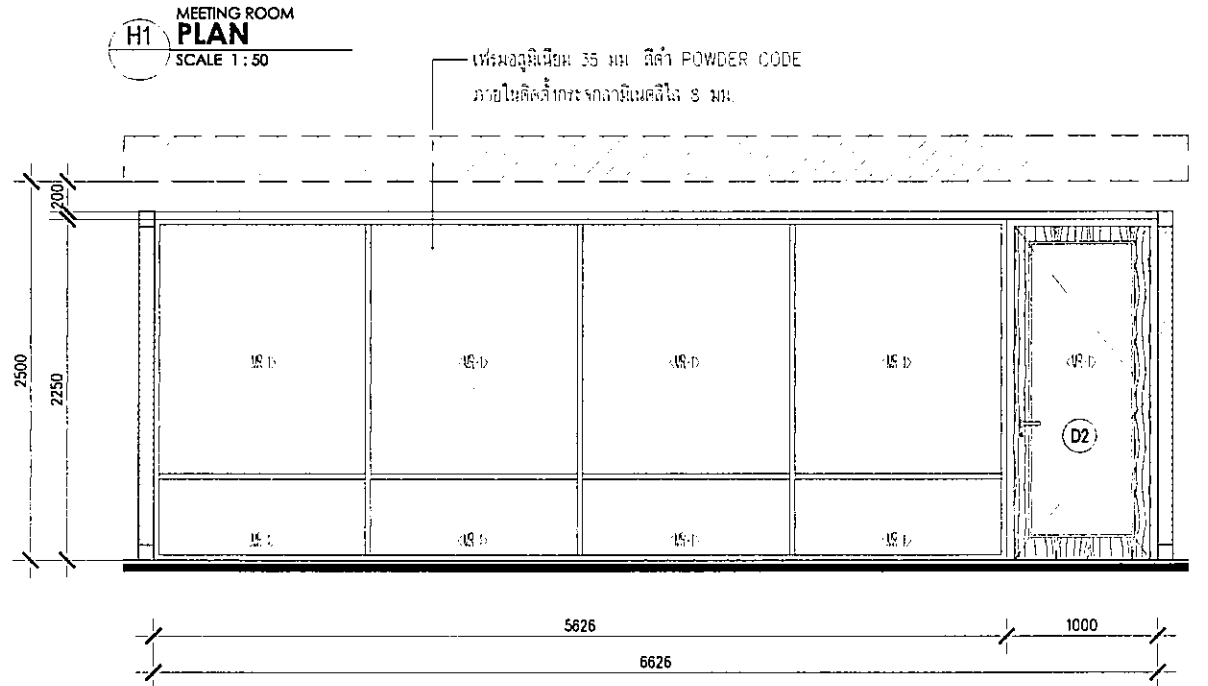
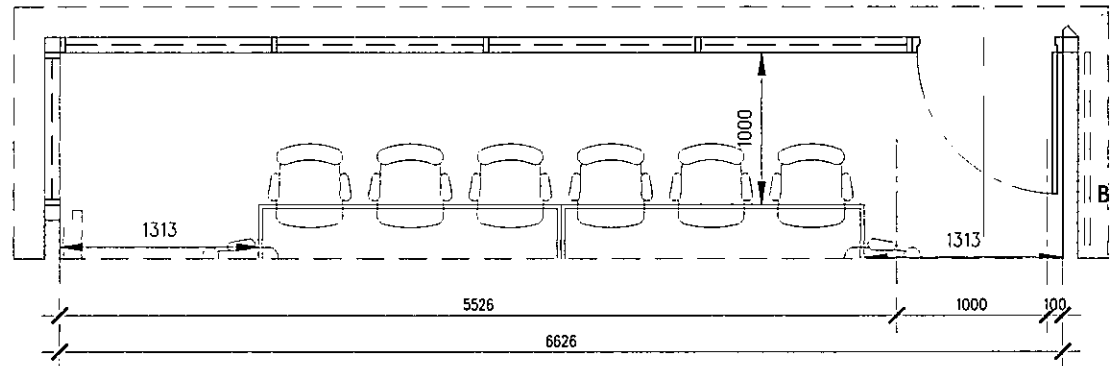
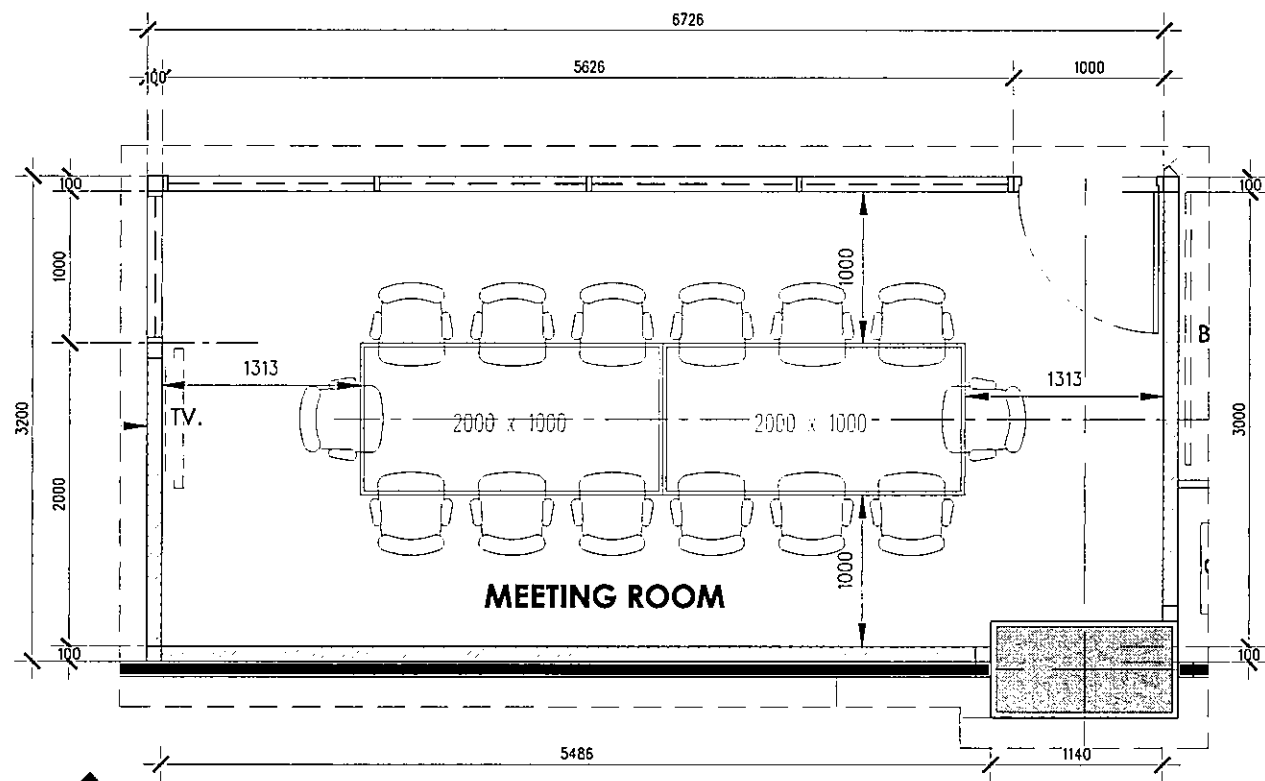

FINISHES LEGEND

CODE	DESCRIPTION	SPECIFICATION
LA-1	LAMINATE ทรายไม้	LAMITAK CODE : WY 1281 D
LA-2	LAMINATE สีน้ำเงินเทา	LAMITAK CODE : SCX 1154 D

CODE	DESCRIPTION	SPECIFICATION
PT-1	ผนังทาสีขาว	TOA SUPER SHILE CODE : M100

CODE	DESCRIPTION	SPECIFICATION
MR-1	กระจกใสหนา 8 มม.	
MR-2	GLASS KOTE	สีชาวนา 8 มม.
MR-3	GLASS KOTE	สีน้ำเงินเทา 8 มม.

Handwritten signature and initials.



Project.
GISTDA HEAD OFFICE
Government Complex - Building B

Drawing Title.
ELEVATION
MEETING ROOM

Revision No.	3	Scale.	1 : 50
Date.	23/08/2018	Drawing No.	ID-14

Do not scale. All measurements are to be checked at site and discretion are to be reported. Drawing is copyright

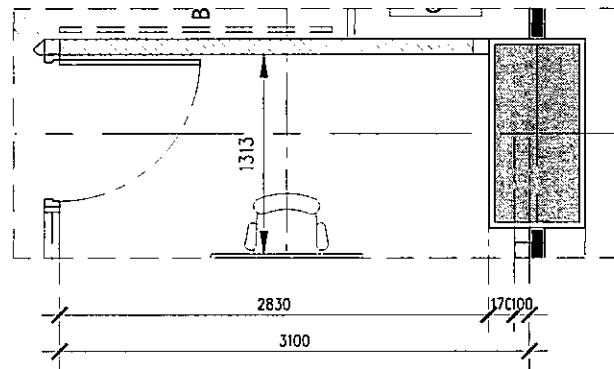

H2 MEETING ROOM PLAN
SCALE 1:50

ผนังโค้งทาสีเรียบสีเทาเรียบทาสี PT-1 สูง 2300 มม

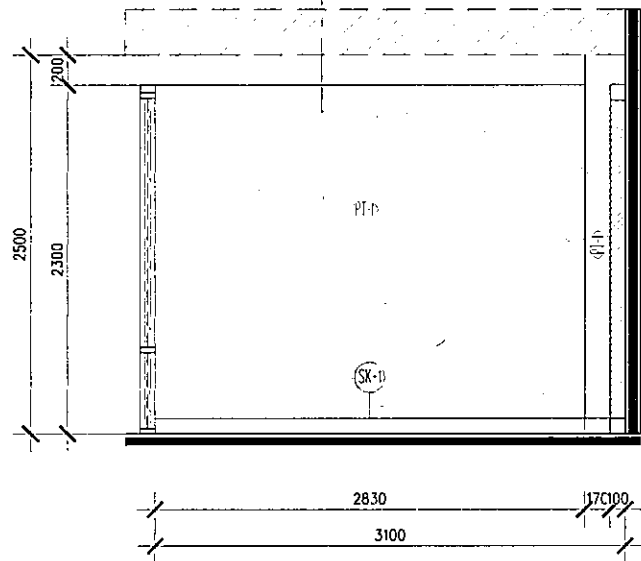

H2 MEETING ROOM ELEVATION
SCALE 1:50

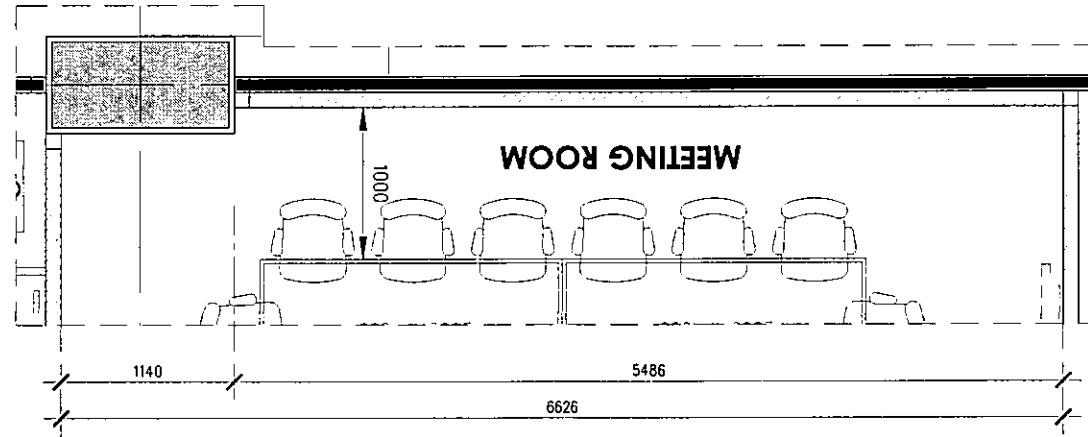

H3 MEETING ROOM PLAN
SCALE 1:50

ผนังทาสีเรียบทาสี PT-1

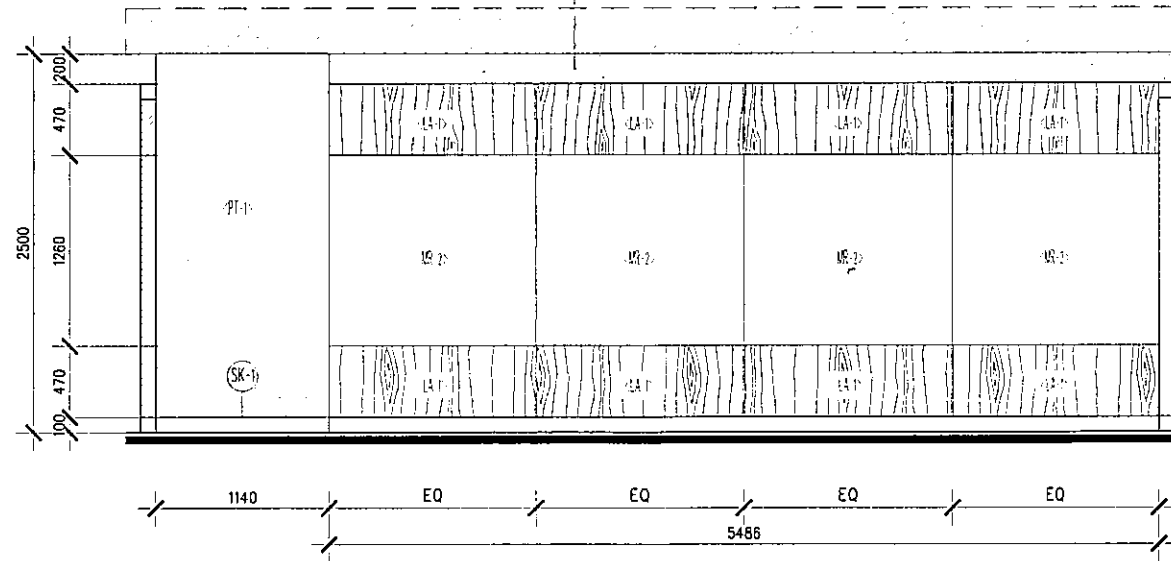

H3 MEETING ROOM ELEVATION
SCALE 1:50

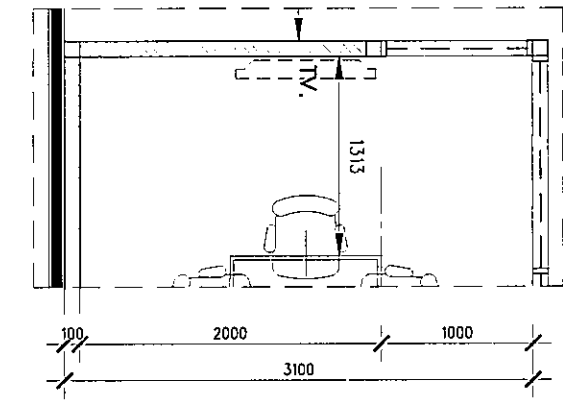

H4 MEETING ROOM PLAN
SCALE 1:50

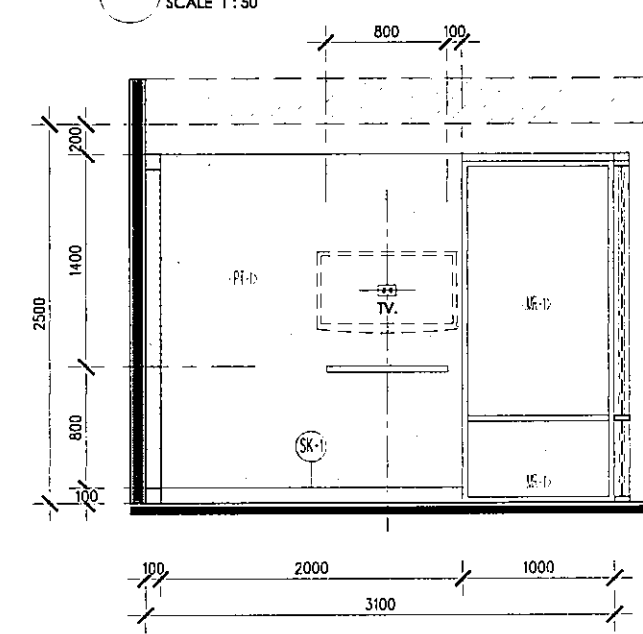

H4 MEETING ROOM ELEVATION
SCALE 1:50

FINISHES LEGEND

CODE	DESCRIPTION	SPECIFICATION
LA-1	LAMINATE ทรายไม้	LAMITAK CODE : WY 1281 D
LA-2	LAMINATE สีน้ำตาลดำ	LAMITAK CODE : SCX 1154 D

CODE	DESCRIPTION	SPECIFICATION
PT-1	ผนังทาสีขาว	TOA SUPER SHILE CODE : M100

CODE	DESCRIPTION	SPECIFICATION
MR-1	กระจกใสหนา 8 มม.	
MR-2	GLASS KOTE	สีชาวดอกไม้ 8 มม.
MR-3	GLASS KOTE	สีน้ำตาลหนา 8 มม.

รวม 3 กิ่ง 199.
สถาปนิก



Project.
GISTDA HEAD OFFICE
Government Complex - Building B

Drawing Title.
ELEVATION
MEETING ROOM

Revision No.	3	Scale.	1:50
Date.	23/08/2018	Drawing No.	ID-15

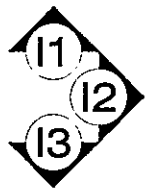
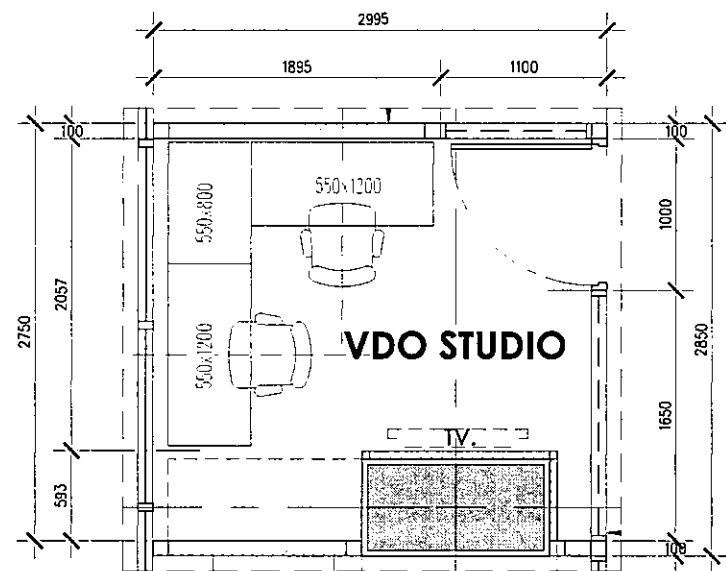

VDO STUDIO AREA
PLAN
SCALE 1 : 50

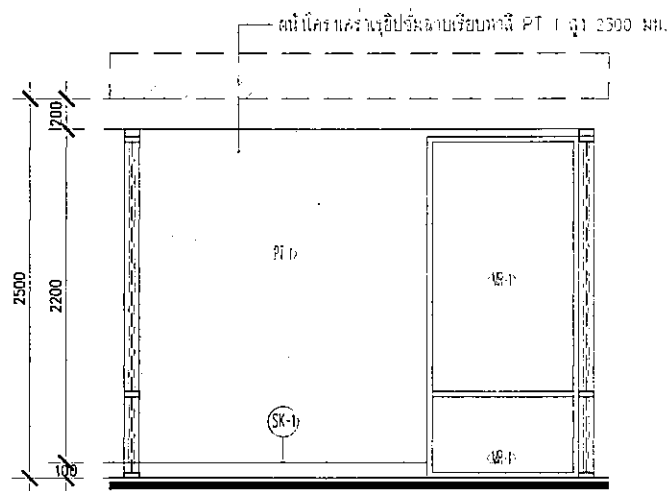

VDO ROOM
ELEVATION
SCALE 1 : 50

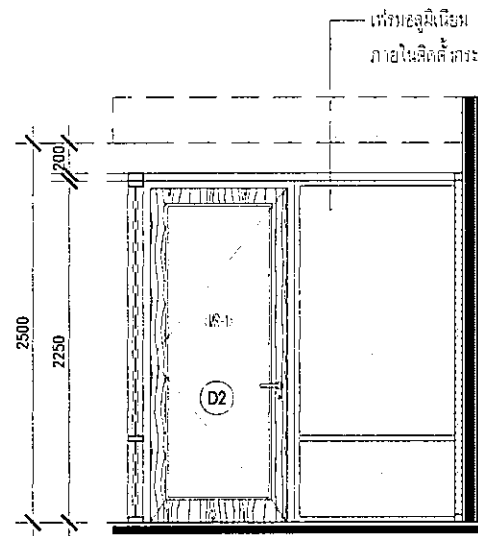

VDO ROOM
ELEVATION
SCALE 1 : 50

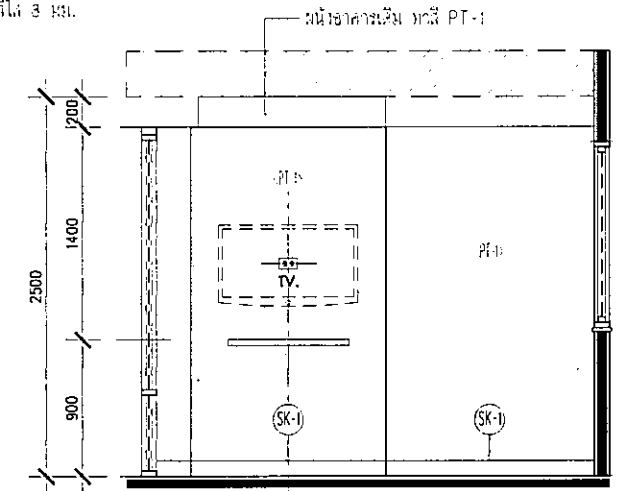

VDO ROOM
ELEVATION
SCALE 1 : 50

FINISHES LEGEND

CODE	DESCRIPTION	SPECIFICATION
LA-1	LAMINATE ทรายไม้	LAMITAK CODE : WY 1281 D
LA-2	LAMINATE สีน้เงินดำ	LAMITAK CODE : SCX 1154 D

CODE	DESCRIPTION	SPECIFICATION
PT-1	ผนังทาสีขาว	TOA SUPER SHILE CODE : M100

CODE	DESCRIPTION	SPECIFICATION
MR-1	กระจกใสหนา 8 มม.	
MR-2	GLASS KOTE	สีชาวนา 8 มม.
MR-3	GLASS KOTE	สีน้ำเงินหนา 8 มม.

Handwritten signature and initials.



Project.

GISTDA HEAD OFFICE
Government Complex - Building B

Drawing Title.

ELEVATION
VDO STUDIO AREA

Revision No.

3

Date.

23/08/2018

Scale.

1 : 50

Drawing No.

ID-16

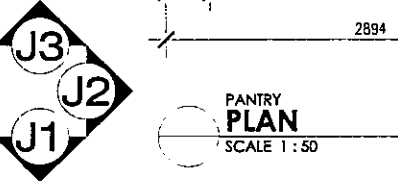
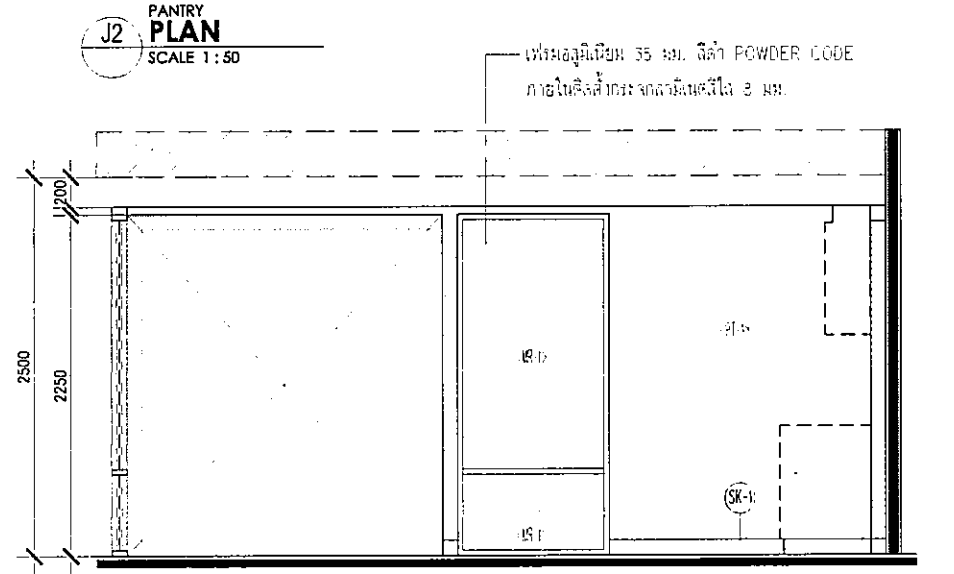
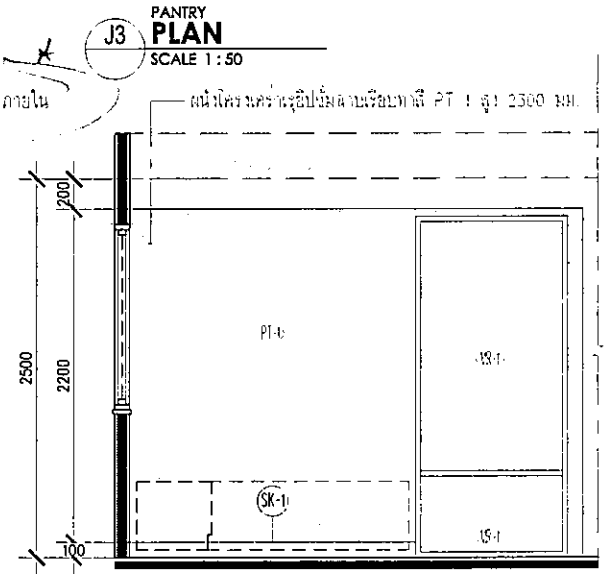
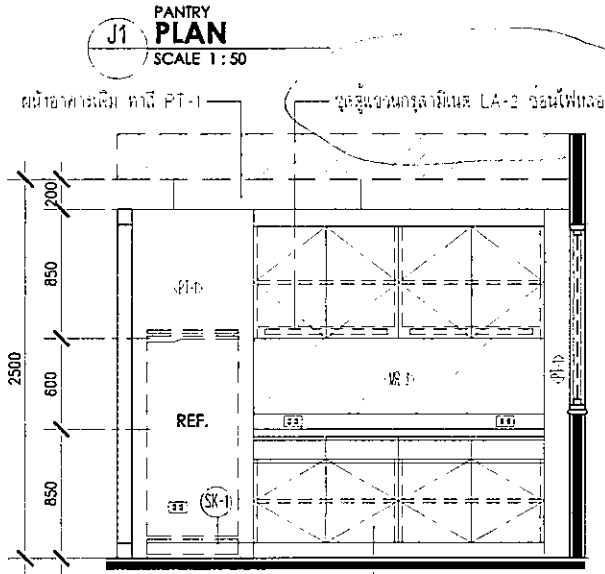
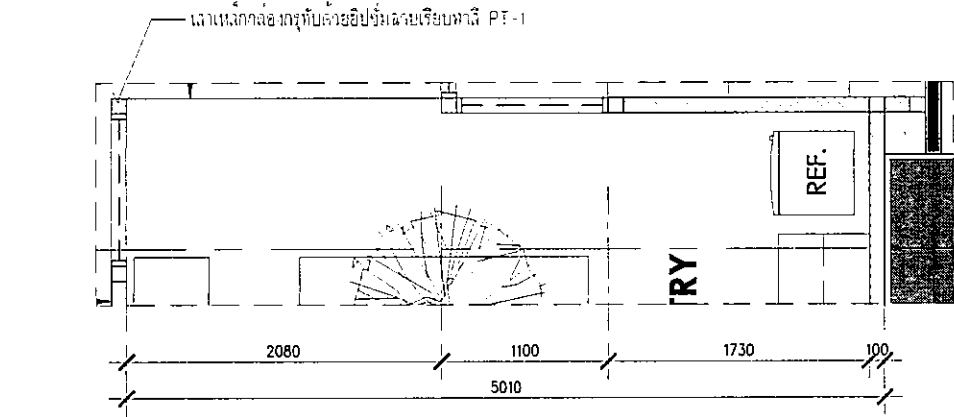
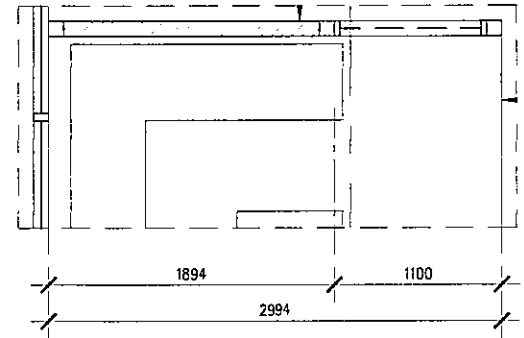
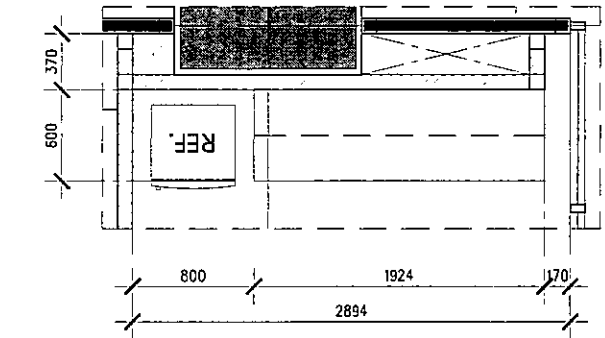
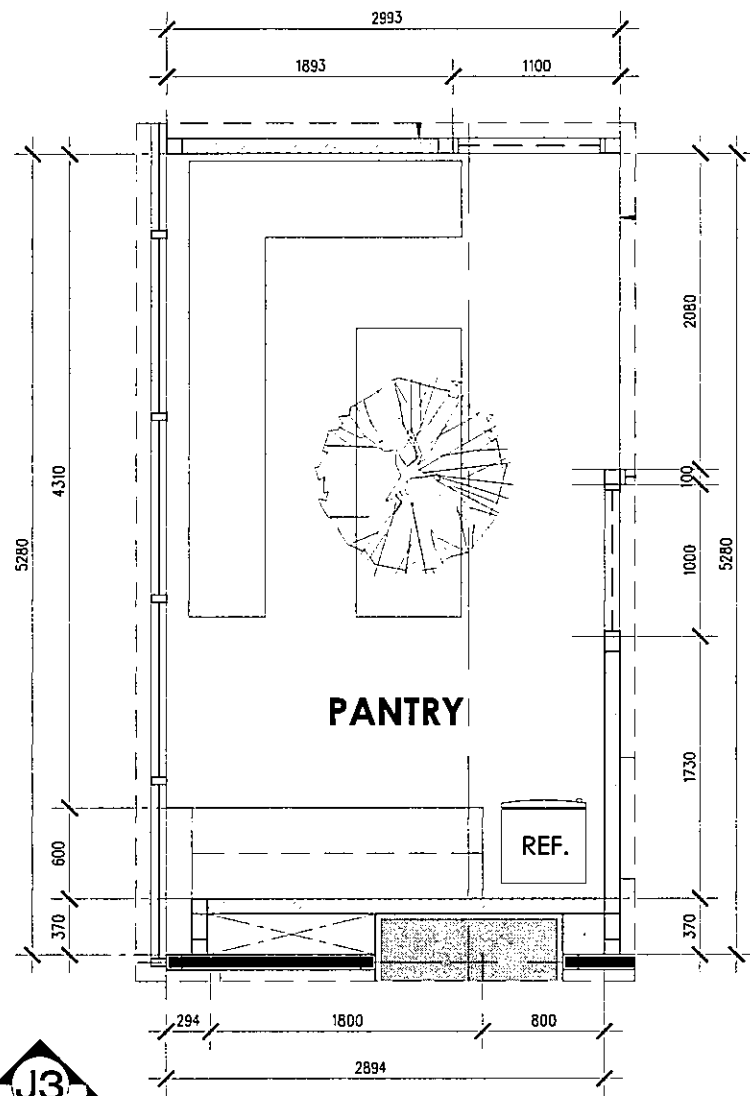

FINISHES LEGEND

CODE	DESCRIPTION	SPECIFICATION
LA-1	LAMINATE ฝาตู้ครัว	LAMITAK CODE : WY 1281 D
LA-2	LAMINATE ผนังตู้ครัว	LAMITAK CODE : SCX 1154 D

CODE	DESCRIPTION	SPECIFICATION
PT-1	ผนังทาสีขาว	TOA SUPER SHILE CODE : M100

CODE	DESCRIPTION	SPECIFICATION
MR-1	กระจกใสหนา 8 มม.	
MR-2	GLASS KOTE	สีขาวหนา 8 มม.
MR-3	GLASS KOTE	สีน้ำเงินหนา 8 มม.

Handwritten signature and initials.

	Project. <p style="text-align: center;">GISTDA HEAD OFFICE Government Complex - Building B</p>	Drawing Title. <p style="text-align: center;">ELEVATION PANTRY</p>	Revision No. 3 Date. 23/08/2018	Scale. 1 : 50 Drawing No. ID-17
	Do not scale. All measurements are to be checked at site and discretion are to be reported. Drawing is copyright			

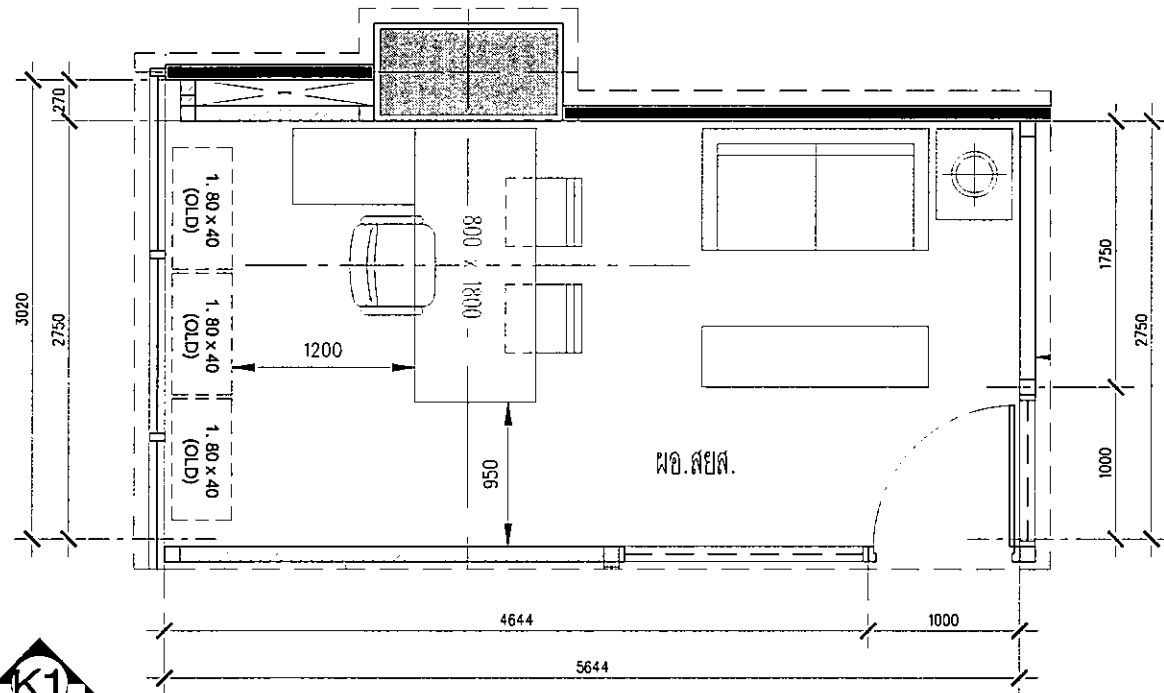

K1
K2
K3

DIRECTOR ROOM PLAN
SCALE 1 : 50

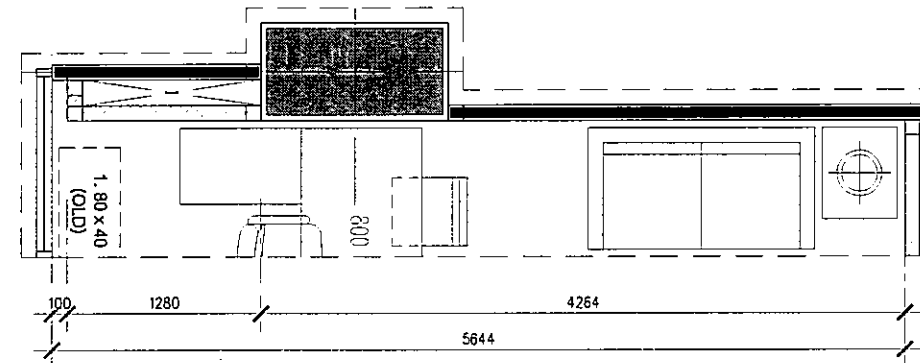

K1

DIRECTOR ROOM PLAN
SCALE 1 : 50

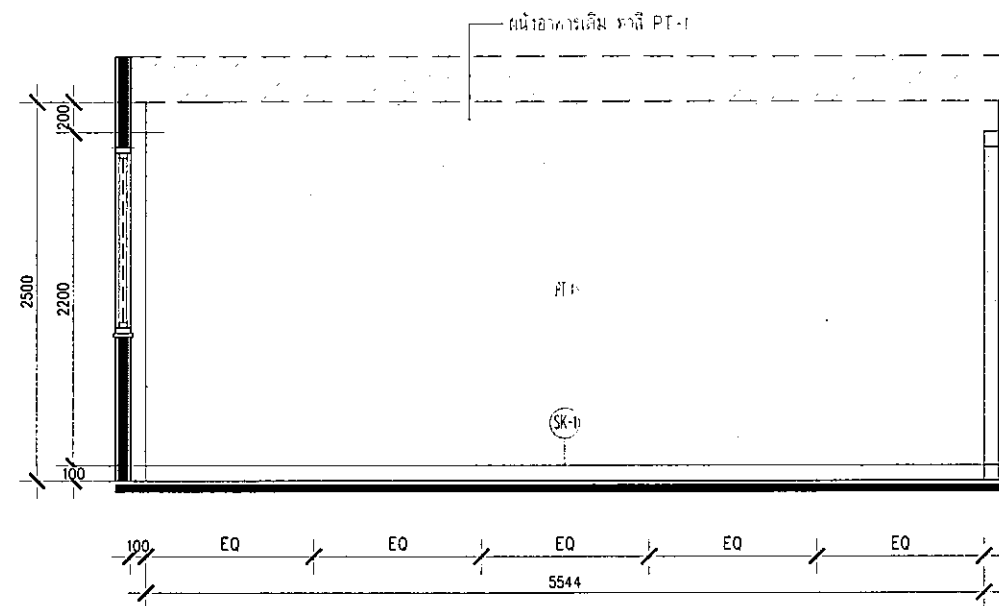

K1

DIRECTOR ROOM ELEVATION
SCALE 1 : 50

FINISHES LEGEND

CODE	DESCRIPTION	SPECIFICATION
LA-1	LAMINATE ทรายไม้	LAMITAK CODE : WY 1281 D
LA-2	LAMINATE สีน้เงินคาน	LAMITAK CODE : SCX 1154 D

CODE	DESCRIPTION	SPECIFICATION
PT-1	ผนังทาสีขาว	TOA SUPER SHILE CODE : M100

CODE	DESCRIPTION	SPECIFICATION
MR-1	กระจกใสหนา 8 มม.	
MR-2	GLASS KOTE	สีชาวนหนา 8 มม.
MR-3	GLASS KOTE	สีน้ำเงินหนา 8 มม.

สม. พ. อ. พ.

สม. พ.



Project.

GISTDA HEAD OFFICE
Government Complex - Building B

Drawing Title.

ELEVATION
DIRECTOR ROOM

Revision No.

4

Scale.

1 : 50

Date.

05/09/2018

Drawing No.

ID-18

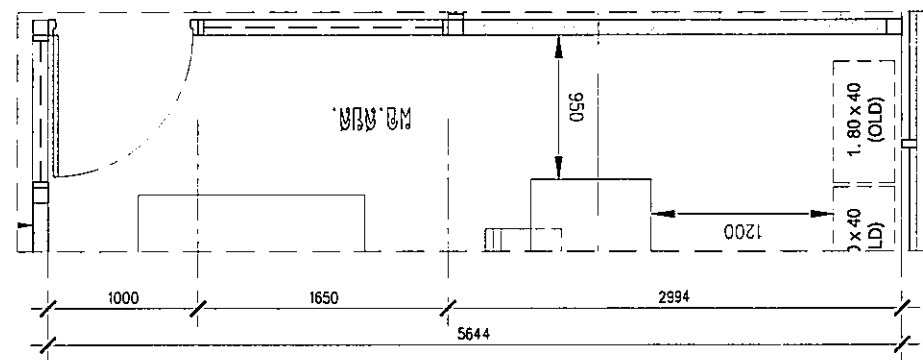

K3
DIRECTOR ROOM
PLAN
SCALE 1 : 50

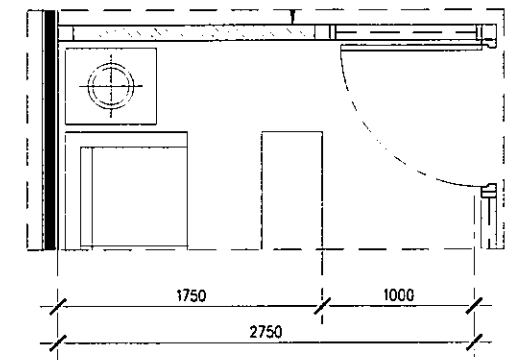

K2
DIRECTOR ROOM
PLAN
SCALE 1 : 50

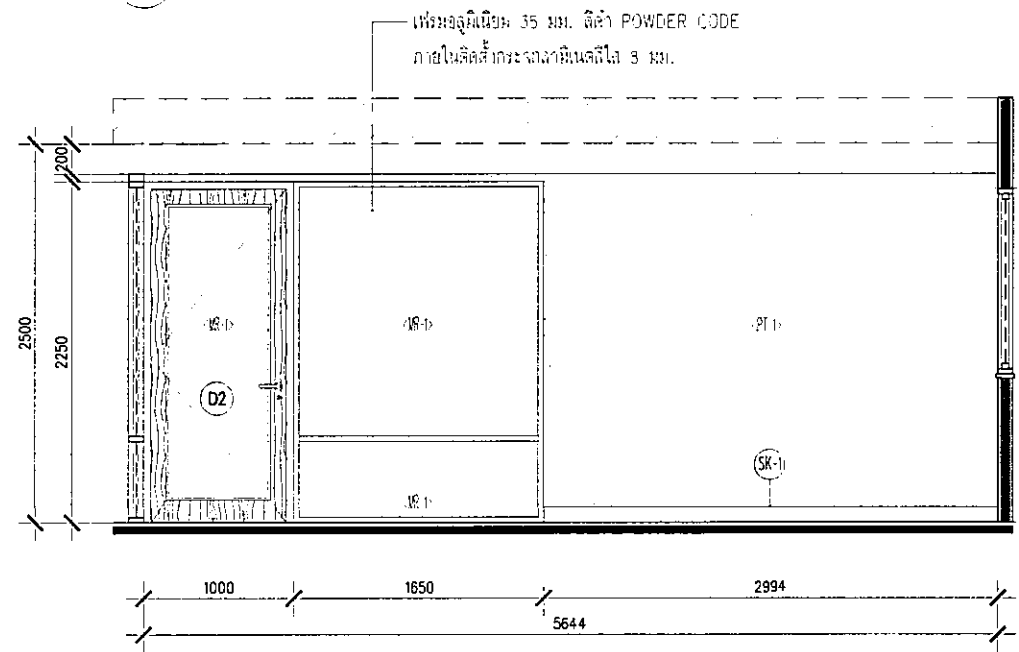

K3
DIRECTOR ROOM
ELEVATION
SCALE 1 : 50

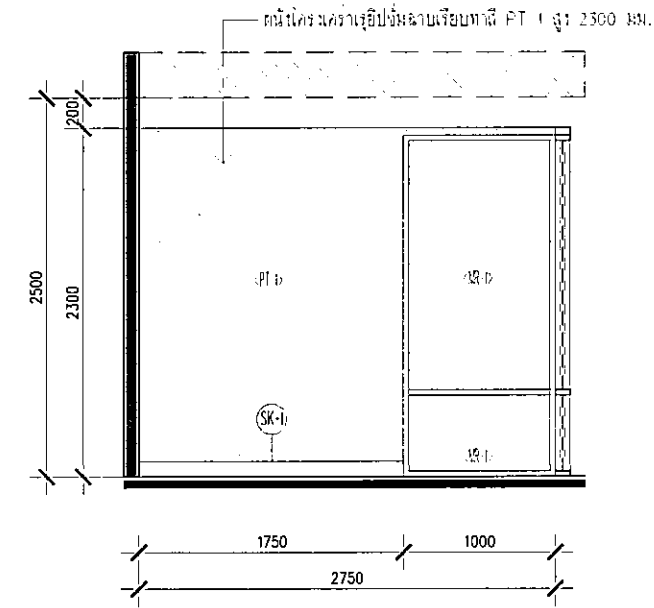

K2
DIRECTOR ROOM
ELEVATION
SCALE 1 : 50

FINISHES LEGEND

CODE	DESCRIPTION	SPECIFICATION
LA-1	LAMINATE ฝ้าเพดาน	LAMITAK CODE : WY 1281 D
LA-2	LAMINATE ผนังเงินดาม	LAMITAK CODE : SCX 1154 D

CODE	DESCRIPTION	SPECIFICATION
PT-1	ผนังทาสีขาว	TOA SUPER SHILE CODE : M100

CODE	DESCRIPTION	SPECIFICATION
MR-1	กระจกใสหนา 8 มม.	
MR-2	GLASS KOTE	สีขาวหนา 8 มม.
MR-3	GLASS KOTE	สีน้ำเงินหนา 8 มม.

ดูผนัง สีขาว ฝ้า
ขนาด



Project.
GISTDA HEAD OFFICE
Government Complex - Building B

Drawing Title.
ELEVATION
DIRECTOR ROOM

Revision No.	3	Scale.	1 : 50
Date.	23/08/2018	Drawing No.	ID-19

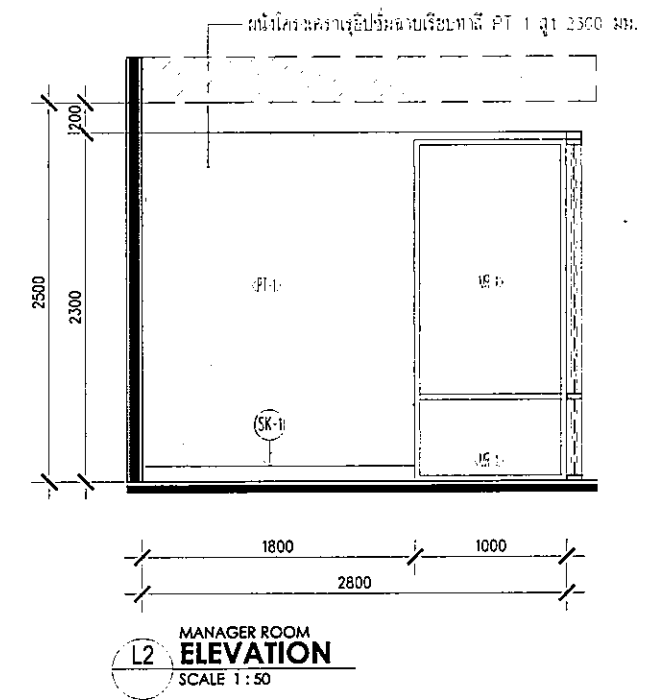
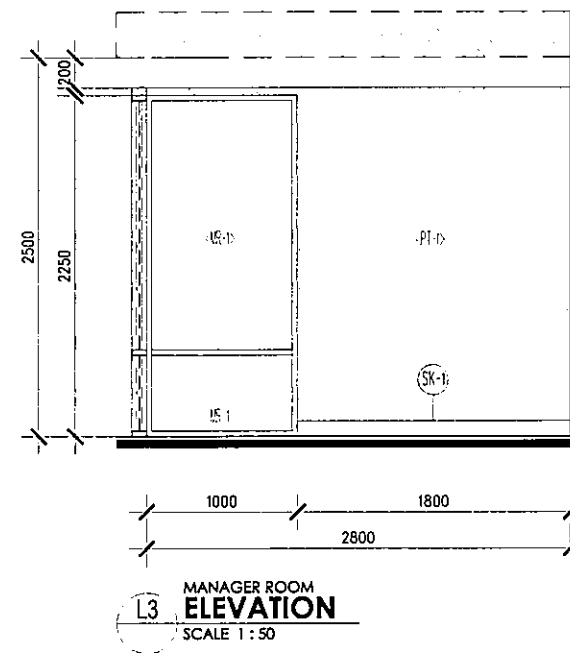
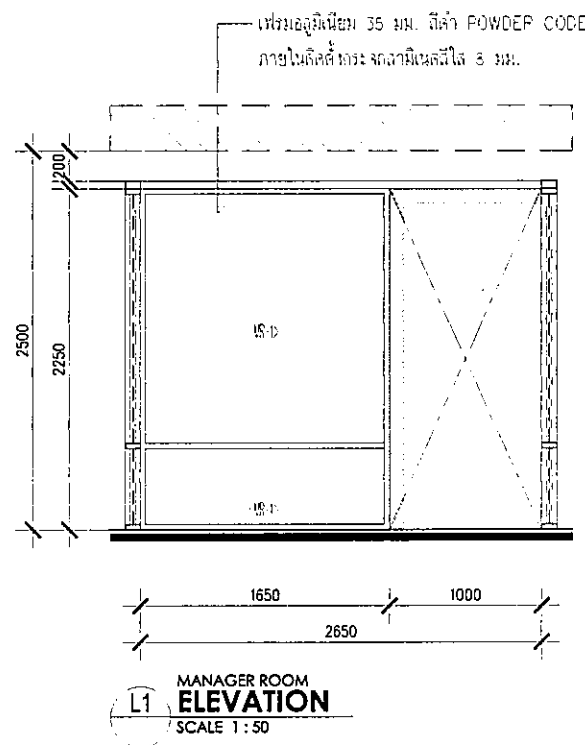
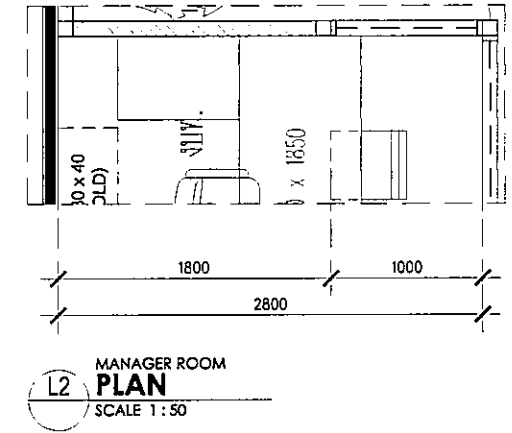
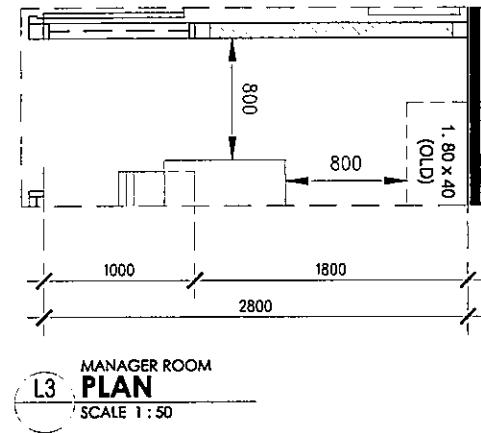
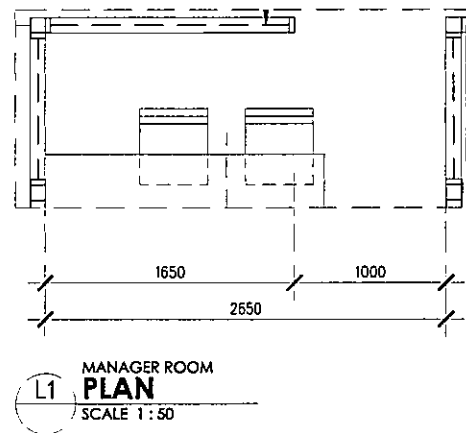
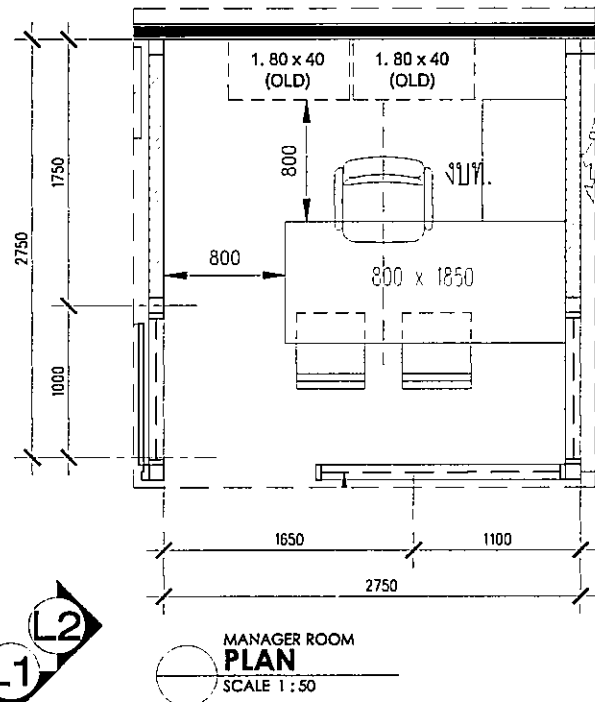

FINISHES LEGEND

CODE	DESCRIPTION	SPECIFICATION
LA-1	LAMINATE ทรายไฟ	LAMITAK CODE : WY 1281 D
LA-2	LAMINATE สีฟ้าเงินดำ	LAMITAK CODE : SCX 1154 D

CODE	DESCRIPTION	SPECIFICATION
PT-1	ผนังทาสีขาว	TOA SUPER SHILE CODE : M100

CODE	DESCRIPTION	SPECIFICATION
MR-1	กระจกใสหนา 8 มม.	
MR-2	GLASS KOTE	สีชาวนาหนา 8 มม.
MR-3	GLASS KOTE	สีน้ำเงินหนา 8 มม.

สม. 15
หน้า,



Project.

GISTDA HEAD OFFICE
Government Complex - Building B

Drawing Title.

ELEVATION
DIRECTOR ROOM

Revision No.

3

Scale.

1 : 50

Date.

23/08/2018

Drawing No.

ID-20