

Figure 16: Example of Steel Mobile shelf*

- 5.3 Two-tier stainless-steel trolley with dimensions greater than or equal to 60 cm long x 90 cm wide X 90 cm high (3 sets)

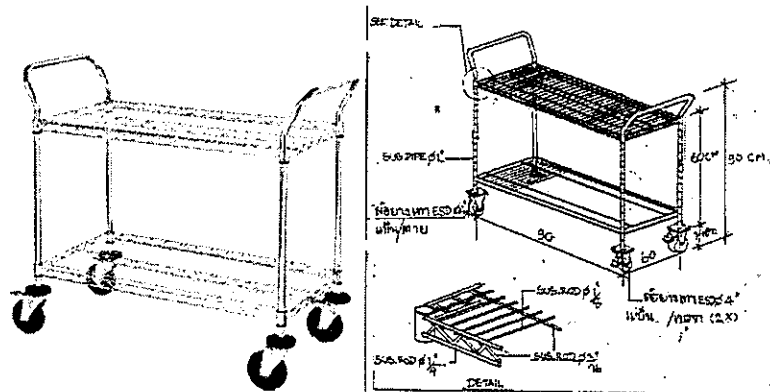

Figure 17: Example of Two-tier Stainless-Steel Trolley*

* (Figure is used for installation and physical characteristics reference only. There is no affiliation to the product.)

43/83
 WU
 h
 ar
 R
 [Signature]

- 5.4 Mobile Instruments Carts with Steel Cabinet with dimensions greater than or equal to 18 "x 24" with 3 shelves (5 sets)

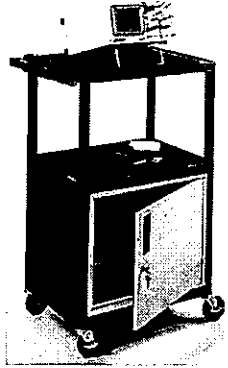

Figure 18: Example of mobile instruments cart*

- 5.5 Utility Carts with Pneumatic Wheels and can support load more than or equal to 225 kg and have the dimensions greater than or equal to 44 inches x 25 inches x 30 inches (3 sets)

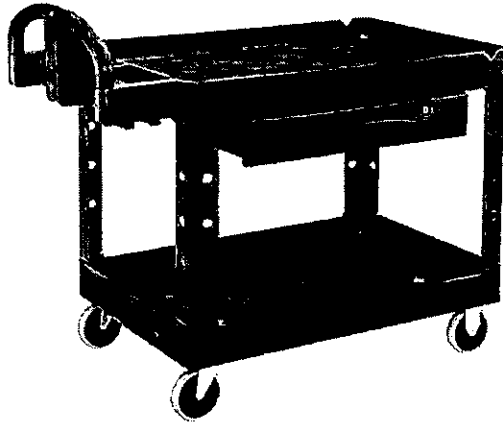

Figure 19: Example of Utility Cart*

* (Figure is used for installation and physical characteristics reference only. There is no affiliation to the product.)

Handwritten signatures and initials, including the date 44/83.

Handwritten marks at the bottom right corner.

- 5.6 Single-tier Stainless steel cart with dimensions greater than or equal to 65 cm long x 50 cm wide x 90 cm height from floor to handle 90 cm with ESD-Safe grey rubber tires (2 sets)

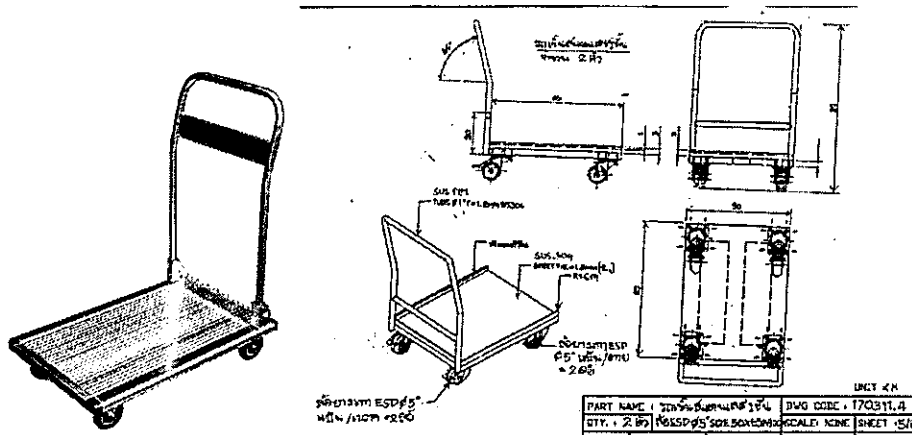

Figure 20: Example of single-tier stainless steel cart*

- 5.7 Plastic Pallet with all sides being similar and can be used on all sides. The width must be no less than 1 meter and must be able to support greater than or equal to 4500 kilograms with a carrying capacity greater than or equal to 1,500 kilograms while moving (5 sets)

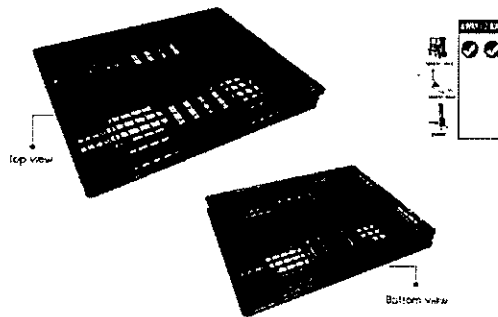

Figure 21: Example of Plastic Pallet that can be used on all four sides*

* (Figure is used for installation and physical characteristics reference only. There is no affiliation to the product.)

Handwritten signatures and initials are present at the bottom right of the page, including a large signature, the number '45/83', and several other initials and marks.

5.8 Five-liter stainless steel trash bin with foot pedal and top for closing (5 sets)

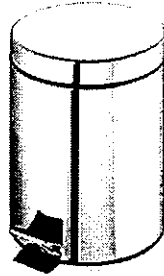

Figure 22: Example of bin with foot pedal*

5.9 A-shape Aluminum ladder with height more than or equal to 1100 mm, 4 steps and tool holder (1 set)

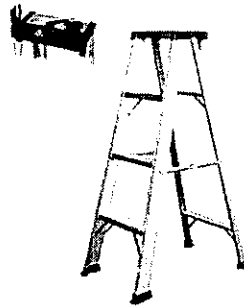

Figure 23: Example of A-shape Aluminum Ladder with 1100 mm height*

5.10 A-shape Aluminum ladder with height more than or equal to 2075 mm, 7 steps and tool holder (1 set)

* (Figure is used for installation and physical characteristics reference only. There is no affiliation to the product.)

Handwritten notes and signatures at the bottom right of the page. The notes include "46/83" and several illegible signatures and initials.

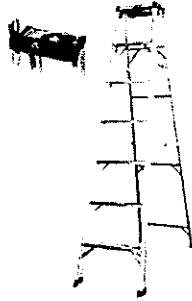

Figure 24: Example of A-shape Aluminum Ladder with 2075 mm height*

5.11 Mobile Stainless-Steel ladder (1 set)

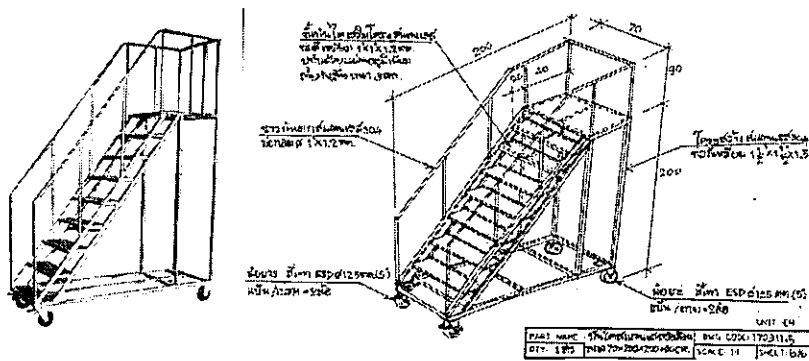

Figure 25: Example of Mobile Stainless-Steel ladder*

Unique features

- (1) The dimensions must be greater than or equal to 70 cm wide x 200 cm long x 200 cm high+ hand rail of 90 cm height
- (2) The structure must be made with stainless steel.
- (3) The step of the ladder floor must be made with anti-slip aluminum.
- (4) The tires must be grey high-quality ESD-Safe tires.

* (Figure is used for installation and physical characteristics reference only. There is no affiliation to the product.)

Handwritten signatures and initials are present at the bottom right of the page. One signature is dated 47/83. There are several other illegible signatures and initials scattered around the bottom right corner.

5.12 Anti-electrostatic Adjustable Wrist Strap with 6ft. Coil Cord (20 sets)

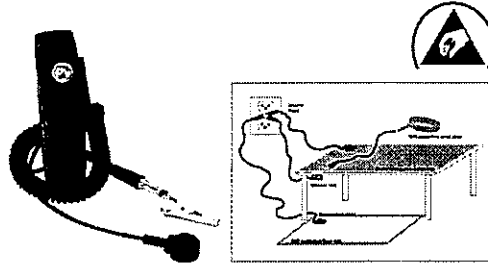

Figure 26: Example of Anti-static adjustable wrist strap

Unique features

- (1) Built-in $1M\Omega$ resistor for safety
- (2) Alligator clip included
- (3) Adjustable type wrist band

6. Forklift for Clean room (1 set)

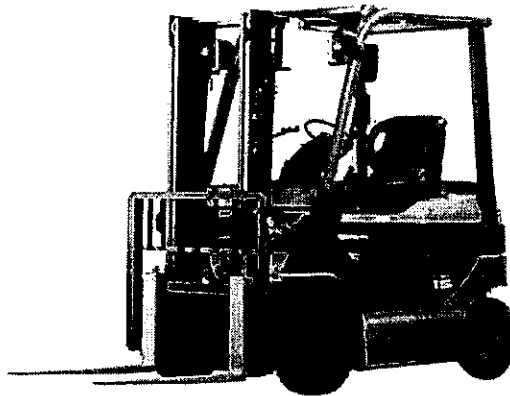

Figure 27: Example of Forklift*

- 6.1 The forklift must be a rider forklift with battery powered, electric motor driven with 4-wheels.

* (Figure is used for installation and physical characteristics reference only. There is no affiliation to the product.)

Handwritten signatures and initials:
WA
h
26
NR
[Signature]
[Signature]
[Signature]

- 6.2 The height of the forklift from the floor to the roof (Overhead Guard Height) must be more than or equal to 2030 mm.
- 6.3 The length to Fork Face + Length of Fork Side must be more than or equal to 3,400 mm
- 6.4 The load Capacity must be more than or equal to 1,000 kg, Load center must be more than or equal to 500 mm, Maximum fork height must be more than or equal to 3,000 mm.
- 6.5 The Mast Lowered Height must be greater than or equal to 1,900 mm.
- 6.6 The Mast Extended with STD Backrest height must be greater than or equal to 4,000 mm.
- 6.7 The height at Free lift with STD Backrest (not lifting hydraulic cylinder) must be greater than or equal to 140 mm.
- 6.8 The Fork length must be greater than or equal to 1,000 mm.
- 6.9 The Turning Radius (Outside) must be greater than or equal to 1,700 millimeters.
- 6.10 The Tilt Range Forward and backward angle must be more than or equal to 7 degree and 11 degree respectively.
- 6.11 The forklift must be powered by an Electric Motors for driving with power output greater than or equal to 7 kW and an Electric Motors for Load Handling with power output greater than or equal to 9 kW.
- 6.12 The battery must have Voltage greater than or equal to 48 volts and Capacity greater than or equal to 330 Ampere-Hour.
- 6.13 The fork must be able to Side Shift (left and right).
- 6.14 There must be control levers for controlling inversion and up-down motion of the hydraulic cylinder.
- 6.15 The turning system must have hydraulic Power Steering.
- 6.16 The braking systems must be hydraulic or similar system which is more efficient and safer.

49 / 83

[Handwritten signatures and initials]

12

01

26

- 6.17 The front and back tires must be white toned tires with standard size as defined by equipment's manufacturer and will not cause smudges or leave mark on any type of floor.
- 6.18 The forklift must have front light, reverse light, turn signal and brake light with audible reverse alarm.
- 6.19 The seat must have a safety switch such that if it doesn't detect the presence of someone sitting in the seat, the hydraulic system will not work.
- 6.20 The Under-Clearance Steer Axle (No Load) must be greater than or equal to 110 mm
- 6.21 The forklift must have anti-rollback capability.
- 6.22 The forklift must be able to automatically right the fork back to 90 degrees.
- 6.23 The forklift must be able to automatically adjust the balance of the forklift body while turning to ensure safety.
- 6.24 The forklift must be able to automatically adjust (reduce) the speed of the fork before the fork touches the ground.
- 6.25 The forklift must have the capability to prevent itself from overturning on an inclined surface. If the accelerator and brake pedal is not pressed on a inclined surface, it must be able to slowly moves down the slope with brief pause.
- 6.26 The forklift must have the capability to measure the brake pedestal sinking and also control the release and hold of the brake during braking.
- 6.27 The forklift must be delivered with a Charger (1 set) which shall work with the electrical systems of the Satellite AIT facility.
- 6.28 The forklift must be delivered with a standard toolset for the forklift (1 set).

50 / 83

[Handwritten signatures and initials]

[Handwritten initials]

[Handwritten initials]

Appendix C.

Technical Specifications – Hand tools.

51 / 83
W. L. L.
[Signature]
[Signature]
[Signature]

Appendix C - Technical Specifications – Hand tools.

1. Screwdrivers and wrenches set (3 sets), each set consists of the set of screwdrivers and wrenches, as follows:
 - 1.1 Hexagon screwdriver set (11 pieces) which includes assorted Hex Driver Blades with extension and Handle (11-Piece Regular End Inch Hex Driver Set) in the size range of 0.050 " - 3/16" inches
 - 1.2 Hexagon screwdriver with ballpoint head set (11 pieces) which includes assorted Hex Driver Blades with extension and Handle (11-Piece Ballpoint Inch Hex Driver Set) in the size range of 0.050 " - 3/16" inches
 - 1.3 Hexagon screwdriver set (9 pieces) which includes Hex Driver Blades with extension and Handle (9-Piece Metric Regular End Metric Hex Driver Set) in the size range of 1.27 - 5 millimeters.
 - 1.4 Hexagon screwdriver with ballpoint head set (9 pieces) which includes Hex Driver Blades with extension and Handle (9-Piece Metric Ballpoint End Metric Hex Driver Set) in the size range of 1.27 - 5 millimeters.
 - 1.5 Screwdriver and Nut Driver Set (13 pieces) including assorted Nut Driver Blades in the size range of 3/16 "-3/8" inches and assorted Screwdriver Blades with extension and handle.
 - 1.6 Hexagon wrench Set Ball-end (9 pieces) including assorted Balldriver Insert Bit Set in the size range of 2-12 millimeters.
 - 1.7 Hexagon Set Ball-end (12 pieces) including assorted Balldriver Insert Bit Set in the size range of 5/64" – 1/2" inches
 - 1.8 Assorted Long-arm L-shape Hexagon wrench set (13 pieces) in the size range of 0.050 "-3/8" inches
 - 1.9 Assorted Long-arm L-shape Hexagon wrench set (15 pieces) in the size range of 1.27- 10 millimeters.
 - 1.10 Assorted Short-arm L-shape Hexagon wrench set (13 pieces) in the size range of 0.050 "-3/8" inches

52 / 83

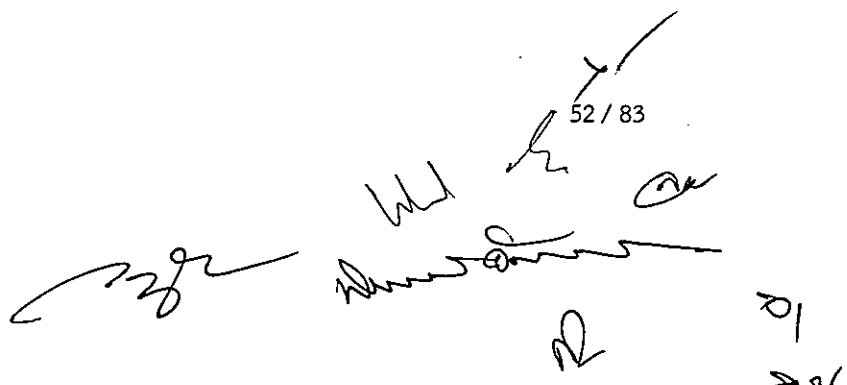

Handwritten signatures and initials are present at the bottom right of the page, including a large signature on the left, a signature in the middle, and several initials and marks on the right.

- 1.11 Assorted Short-arm L-shape Hexagon wrench set (9 pieces) in the size range of 1.5-10 millimeters.
- 1.12 Assorted Balldriver L-shape Hexagon wrench set (13 pieces) in the size range of 0.050 "-3/8" inches
- 1.13 Assorted Balldriver L-shape Hexagon wrench set (15 pieces) in the size range of 1.27 – 10 millimeters
- 1.14 Assorted T-Handles Hexagon End wrench (10 pieces) in the size range of 3/32" -3/8 " inches
- 1.15 Assorted T-Handles Hexagon End wrench (8 pieces) in the size range of 2-10 millimeters
- 1.16 Assorted T-Handles Hexagon Ball End wrench (10 pieces) in the size range of 3/32" - 3/8 " inches
- 1.17 Assorted T-Handles Hexagon Ball End wrench (7 pieces) in the size range of 2-10 millimeters
- 1.18 Assorted Fold-Up Key Hexagon Wrench Set (9 pieces) in the size range of the 0.050 "- 1/4" inches
- 1.19 Assorted Fold-Up Key Hexagon Wrench Set (7 pieces) in the size range of the 1.5-8 millimeters
- 1.20 Assorted Pivot Head Hexagon wrench set (6 pieces) in the size range of the 3-10 millimeters
- 1.21 Assorted Pivot Head Hexagon wrench set (8 pieces) in the size range of the 1/8" – 3/8" inches

2. Torque wrenches and screwdrivers (3 sets), each set consists of the set of screwdrivers and wrenches, as follows:

- 2.1 Torque Screwdriver, size 1/4 " inches with Capacity 4-20 cNm
- 2.2 Torque Screwdriver, size 1/4 " inches with Capacity 15-75 cNm

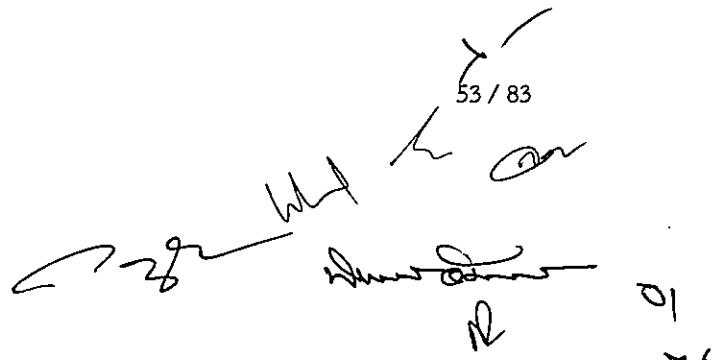
53 / 83

- 2.3 Click Wrenches with removable ratchet, 9x12 End Fitting, size 1/4" inches Drive, Capacity 1-5 cNm
 - 2.4 Click Wrenches with removable ratchet, 9x12 End Fitting, size 1/4" inches Drive, Capacity 5-25 cNm
 - 2.5 Click Wrenches with removable ratchet, 9x12 End Fitting, size 3/8" inches Drive, Capacity 5-25 cNm
 - 2.6 Click Wrenches with removable ratchet, 9x12 End Fitting, size 3/8" inches Drive, Capacity 10-50 cNm
 - 2.7 Torque wrench accessory - Open End Bits, End Fitting 9x12, assorted size (13 pieces) in the size range of the 7-19 millimeters
 - 2.8 Torque wrench accessory - Open End Bits, End Fitting 9x12, assorted size (8 pieces) in the size range of the 1/4" – 3/4" inches
 - 2.9 Torque Wrench Head, Square Drive, End Fitting 9x12, size 3/8" inches
 - 2.10 Crowfoot Square Set 3/8" Drive (8 pieces) assorted size in the range of 5/8" -1 1/16" inches
3. Screwdrivers set (3 sets) , each set consists of the set of screwdrivers, as follows:
- 3.1 Assorted Slotted Screwdrivers (13 pieces) with blade length in the region of 60 – 250 mm. with at least 2 pieces each having 3mm., 4mm., 5.5 mm and 6.5mm and at least 1 piece each having 2.5mm, 3.5mm, 8mm, 10mm and 12mm
 - 3.2 Assorted Stubby Slotted Screwdrivers (3 pieces) with blade length of 4, 5.5 and 6.5 mm.
 - 3.3 Assorted Phillips Screwdrivers set (10 pieces) Each size and length of blade is in the range of 60-250mm. with at least 2 pieces each of size PH0, PH1, PH2 and at least 2 piece each of size PH3 and PH4.
 - 3.4 Stubby, short blade length Phillips screwdriver set (2 pieces) of size PH1 and PH2.
 - 3.5 Pozidriv Screwdriver set (5 pieces) with blade length in the region of 60 – 250 mm. and size PZ0, PZ1, PZ2, PZ3, PZ4

54 / 83

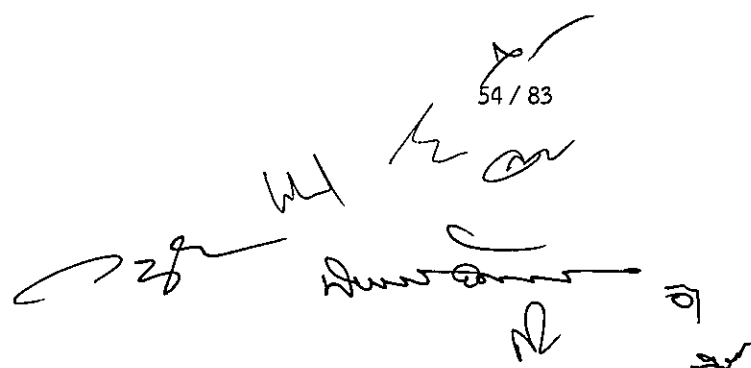

- 3.6 Stubby Pozidriv Screwdriver set (2 pieces) with blade length in the region of 25 - 35 mm. and size PZ1, PZ2
 - 3.7 Offset Slotted / Phillips Screwdrivers set (3 pieces) with offset slotted of size 4mm, 5mm, PH1xPH2
 - 3.8 Jeweler's Screwdriver Set / Precision Screwdriver Set
 - 3.9 Assorted Nut Drivers Screwdriver set (10 pieces) with size in the range of 4 - 13 mm.
 - 3.10 Assorted Nut Drivers Screwdriver set (10 pieces) with size in the range of 3/16" - 9/16" inches.
 - 3.11 Minimum 11 pieces of accessories including handle and blade of Slotted, PHILIPS, POZIDRIV, TORX, HEX type
4. Socket Sets of size 1/4" inches Drive (3 sets of each size range) with Socket sizes in the range of 4 - 13 mm. and 3/16 "- 1/12" inches.
5. Wrench Set (3 sets), each set consists of the set of wrenches, as follows:
- 5.1 Assorted Combination Wrench Set (17 pieces) in the size range of the 6-24 mm.
 - 5.2 Assorted Combination Wrench Set (17 pieces) in the size range of the 1/4" - 1 1/4" inches
 - 5.3 Ratchet combination wrenches (Straight) (18 pieces) in the size range of the 8-32 mm
 - 5.4 Hinged Joint combination wrenches (12 pieces) in the size range of the 8-19 mm
 - 5.5 Double Open-End Wrenches (24 pieces) in the size range of the 6x7 - 30x32 mm
 - 5.6 Double Open-End Wrenches (10 pieces) in the size range of the 1/4 "x 5/16" - 1 1/8"x 1 1/4" inches
 - 5.7 Double Ring-End Wrenches (12 pieces) in the size range of the 6x7 - 30x32 mm
 - 5.8 Ratcheting Adjustable Wrenches (3 pieces) with the size of 6 ", 8", 10" inches
6. Tool cart with toolbox (1 set) which include 1 tool cart with the following tools in the cart:
- 6.1 Tool cart with toolset (1 set) with at least 7 drawers with 1 toolbox which must have at least 4 drawers and more than 350 tools.

Handwritten signatures and initials are present at the bottom of the page, including a large signature on the left, a signature in the center, and initials on the right.

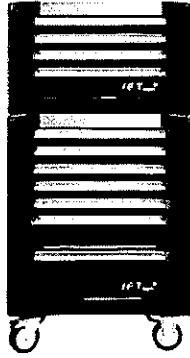

Figure 28: Tool cart with toolbox*

Unique features

- (1) must have locking mechanism
- (2) must have a handle for easy transportation.
- (3) must have soft bumper, to prevent jolt, on all four corners
- (4) must have heavy duty wheels and provide high resistance to heavy loads with wheel locking mechanism
- (5) The Work top of the cart must be able to support at least 900kg
- (6) The drawer must be able to support total load no less than 150 kg.
- (7) The drawer must be laid with foam that has been cut to fit precisely with the provided tools

6.2 Toolbox within the tool cart must have more than 350 tool pieces and must include the following tools:

- 6.2.1 Combination Wrenches
- 6.2.2 Open-End Wrenches
- 6.2.3 Flare-nut Wrenches
- 6.2.4 Open-End Wrenches
- 6.2.5 Adjustable Wrenches
- 6.2.6 Pin Wrench

* (Figure is used for installation and physical characteristics reference only. There is no affiliation to the product.)

Handwritten signatures and initials:
A large signature on the left side of the page.
A signature in the center, possibly reading "Wahid".
A signature on the right side, possibly reading "H. M. A.".
A signature at the bottom right, possibly reading "R. M. A.".

- 6.2.7 1/2" Socket Sets and accessories
- 6.2.8 1/2" Long Drive Hinged Handle
- 6.2.9 1/4" Sockets and accessories
- 6.2.10 3/4" Sockets and accessories
- 6.2.11 Torque Wrench
- 6.2.12 Screwdrivers for Slotted Heads, Philips, Pozidriv
- 6.2.13 Hexagonal Blade Screwdriver for Slotted, Phillips, Pozidriv
- 6.2.14 1,000 Volts Insulated Screwdrivers Slotted, Phillips
- 6.2.15 Multifunction Tester
- 6.2.16 Voltage Tester Screwdriver
- 6.2.17 Screw Starter for Slotted Heads
- 6.2.18 Sleeve set of hexagonal Keys, Spherical Head Hex Keys
- 6.2.19 Torx Keys
- 6.2.20 Case set of screwdrivers
- 6.2.21 Pliers
- 6.2.22 Nippers
- 6.2.23 Clamp
- 6.2.24 Circlip
- 6.2.25 Cutters
- 6.2.26 Locking Tape Measure
- 6.2.27 Scriber
- 6.2.28 Rule
- 6.2.29 Feeler Gauge 19 blades
- 6.2.30 Hacksaw Frame
- 6.2.31 Hacksaw Blades
- 6.2.32 Files
- 6.2.33 Square Punch
- 6.2.34 Right-cut scroll tool

Handwritten signatures and initials:
A large signature on the left, possibly "26".
A signature in the middle, possibly "Dun...".
Initials "WLD" and "LH" above the signature.
Initials "AR" and "R" to the right of the signature.
A small mark resembling a checkmark or the number "7" at the bottom right.

- 6.2.35 Scraper
- 6.2.36 Box set of drill-bits
- 6.2.37 Tap and die set
- 6.2.38 Ratchet tool-holder
- 6.2.39 Riveting Hammers
- 6.2.40 Plastic-tip mallet
- 6.2.41 Dead-blow hammer
- 6.2.42 Chisel
- 6.2.43 Wire Stripper
- 6.2.44 Crimping pliers

7. Pliers and cutters set (3 sets) each consisting of the following types of pliers: (Note: Items 7.1-7.8 must meet the ESD-Safe standard, that is, it prevents electrostatic discharge which prevent rapid electrical discharge and affect electronic components).

- 7.1 Oval Head Cutters (1 piece)
- 7.2 Tapered Head Cutters (1 piece)
- 7.3 Relieved Head Cutters (1 piece)
- 7.4 Flush Cutting Edges (1 piece)
- 7.5 Round Nose Pliers (1 piece)
- 7.6 Short Nose Pliers (1 piece)
- 7.7 Long Nose Pliers (2 pieces), 1 piece each of Smooth Jaws and Serrated Jaws type
- 7.8 Tweezers (1 set), each with minimum of 5 pieces per set, such as the 2A, 3C, 5, 7, 00 set or AA, 00, 2A, 3C, 5, 7 set or 2A, 3, 00, 6, 7 set
- 7.9 Circlip Pliers Set (4 pieces) which includes the External Circlip Pliers (Straight-with Spring), External Circlip Pliers (Bent-with Spring), Internal Circlips Pliers (Straight-with Spring), Internal Circlips Pliers (Bent-without Spring)
- 7.10 Screw Removal Pliers (2 pieces), with each having different jaw
- 7.11 Locking Pliers, Mole Grip, Vice-Grip Pliers (2 pieces), with size 6LN and 10WR
- 7.12 Wire Twisting Pliers (1 piece)

Handwritten signatures and initials are present at the bottom of the page, including a large signature on the left, several smaller signatures in the center and right, and the number '12' at the bottom right.

7.13 Stripper, Cutter and Crimper (Bolt Cutter) (2 piece each) with 1 type each with unit in millimeters and the other in inches

8. Inspection / Marking up tools (3 sets)

8.1 LED Magnifiers Lens (1 set)

8.2 Digital Microscope with Polarizer (1 set) with magnification more than or equal to 20x-220x, 1.3 M Pixels with the following accessories.

8.2.1 Wi-Fi connectivity

8.2.2 Backlight illuminator for both Brightfield and Darkfield illumination

8.2.3 Stand and table top stand with quick-release

8.2.4 X-Y sliding platform with 360-degree swivel base

8.2.5 Backlight Pad (Polarizer)

8.3 Circular Inspection Mirror (2 pieces), assorted small and large size

8.4 Rectangular Inspection Mirror (2 pieces), assorted small and large size

8.5 LED Pen Light Aluminum Tube

8.6 Stainless Steel Rule Rounded End, size 6" inches

8.7 Stainless Steel Rule Rounded End, size 12" inches

8.8 Powerlock Measuring Tape Rules, 5m long

8.9 Feeler gauge , 19 blades, 0.04-1 millimeter

8.10 Digital Micrometer Moore and Wright with measuring range of 0-25 millimeters

8.11 Digital/Electronic Caliper Stainless Steel frame with measuring range of 0-150 millimeters

8.12 Analog Vernier Calipers with measuring Needle and measuring range of 0-300 millimeters

8.13 Assorted Scribes (at least 4 pieces)

8.14 G-Clamp, size 100 millimeters

8.15 Dial Gauge, needle type, size 0-100 millimeters

8.16 Spirit Level, size more than 200 millimeters

8.17 Self-leveling Cross-Line Laser with Plumb Points

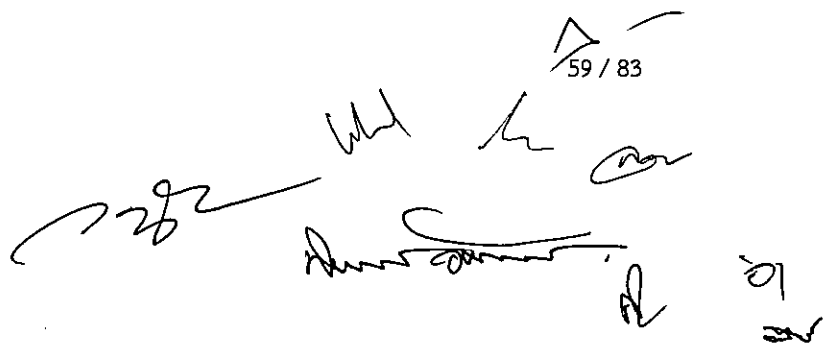
59 / 83

9. General tools (3 sets), with each set including the following tools or better:

9.1 Cordless Impact Hand-held drill - 12 V

9.1.1 The Torque must be greater than or equal to (hard / soft): 30/13

9.1.2 The Idle speed must be greater than or equal to (1st gear/2nd gear): 0-380/0-1300 rpm

9.1.3 The type of battery must be lithium-ion.

9.2 Heat Gun

9.2.1 The Power must be greater than or equal to 2000W

9.2.2 Adjustable levels with more than or equal to 3 levels.

9.2.3 Adjustable heating level in the range of 50-630°C.

9.2.4 Must produce air volume in the range of 120-550 liters/minute

9.2.5 Must have Electronic temperature control system with digital dial

9.3 Jigsaw

9.3.1 The Rated power input must be more than or equal to 710W

9.3.2 . The stroke range must be more than or equal to 500-3100 time/minute.

9.3.3 The Stroke range must be greater than or equal to 20mm

10. Hammers (3 sets) with each set including the following items or better:

10.1 Ball Pein Hammer with diameter of 1/2" inches

10.2 Ball Pein Hammer with diameter of 1 1/2" inches

10.3 Dead Blow Hammer Nylon Tip with diameter of 40 millimeters

10.4 Dead Blow Hammer with steel micro balls with diameter of 60 millimeters

11. Infrared Thermometer (1 set)

11.1 General Features

The Infrared Thermometer must be able to display the heat image and indicate the source of heat clearly as well as simultaneously capture an optical image with the thermal image as well as record audio and save onto memory card and can also produce report on the computer and mobile devices that support the application.

60/83
Wh
L
an
R
25

11.2 Technical Features including Imaging Performance:

- 11.2.1 The Field of View must be greater than or equal to 34 degree (Horizontal) x greater than or equal to 24 degree (Vertical).
- 11.2.2 The Minimum Focus Distance must be less than or equal to 15 centimeters
- 11.2.3 The IFOV with standard lens must be less than or equal to 0.93 mRad
- 11.2.4 The IFOV with 2x telephoto lens must be less than or equal to 0.46 mRad
- 11.2.5 Must have at least the following focus capability - Laser sharp Auto Focus, Multi Sharp Focus and Manual Focus
- 11.2.6 Must have Detector Type - Focal Plane Array (FPA) Uncooled, microbolometer, 640 x 480 pixels (1280 x 960 with Super Resolution)
- 11.2.7 Must have Visible Light Camera Built-in with resolution more than or equal to 5.0 megapixels
- 11.2.8 Must have at least the following On Camera Operating Modes - Full thermal, thermal-visual imager
- 11.2.9 The Measurement Temperature Range must be less than or equal to -20°C to greater than or equal to 800°C
- 11.2.10 The LCD Panel must be more than or equal to 3.5 "Color LCD (640 x 480) with Touch Screen capability
- 11.2.11 Must be able to support Laser distance meter and calculates distance
- 11.2.12 Must have the following Storage Medium capability - micro SD card, Flash memory, USB Flash with minimum support for size larger than or equal to 4GB
- 11.2.13 Must be able to streaming video via USB and HDMI
- 11.2.14 Must have Rechargeable Li-Ion battery system
- 11.2.15 Must have 2-bay intelligent charger powered via AC outlet for battery charging
- 11.2.16 The Operating temperature range must be less than or equal to -10°C to greater than or equal to 50°C
- 11.2.17 Must meet the Environmental Protection IP 54 standard
- 11.2.18 Must meet the Shock 25G standard IEC 68-2-29

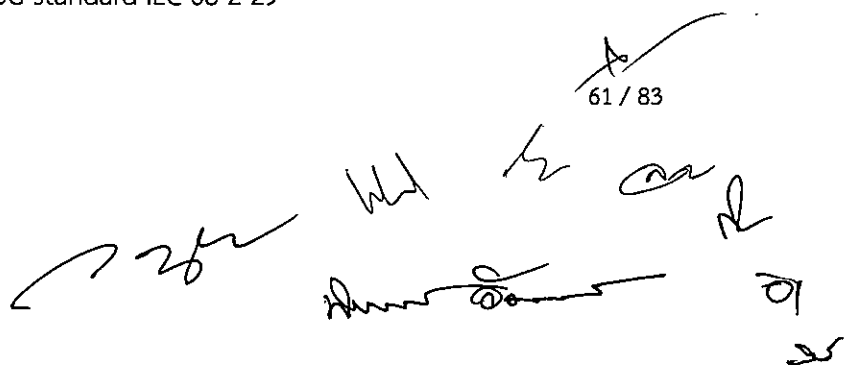

Handwritten signatures and initials are present at the bottom of the page, including a large signature on the left and several smaller initials and marks on the right.

11.2.19 Must meet the Drop2 meter standard with standard lens

11.2.20 Must meet the Safety Standards IEC 61010-1

11.2.21 The software must be able to manage and manipulate the Thermal Image data and the software must be able to be installed in unlimited number of computers.

11.3 Accessories:

11.3.1 Carrying case (soft and hard) (1 set)

11.3.2 Rechargeable battery packs with 2 LED indicated energy (2 sets)

11.3.3 Micro SD Card (1 set)

11.3.4 Infrared Telephoto (2X magnification) (1 set)

11.3.5 Infrared Wide-Angle Lens (1 set)

11.3.6 Tripod Mounting Accessory with Tripod (1 set)

62 / 83

